

Photonic topological insulators and Type-II Weyl points

Mikael C. Rechtsman, Penn State

Columbia, May 2017

Part 1: Background on photonic topological insulators

(collaboration with Segev group, Technion and Szameit group, Jena)

MCR et al., Nature 496, 196-200 (2013)

What are topological insulators?



- Topological insulators are insulators in the bulk but metallic on the edges.
- Most importantly: **the edge states are scatter-free!**

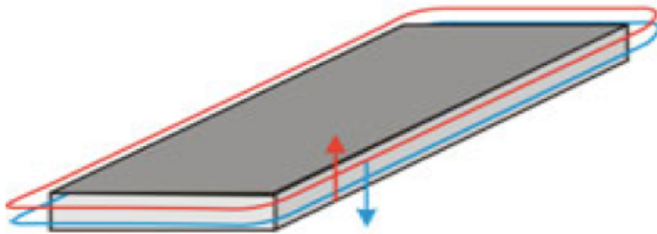

Kane and Mele, Phys. Rev. Lett. 95, 226801 (2005)
Hughes et al., Science 314, 5806, 1757-1761 (2006)
Hsieh et al., Nature 452, 970-974 (2008)
Chen et al., Science 325 (5937) 178-181 (2009)
Hsieh et al., Nature 460, 1101-1105 (2009)

- Why?

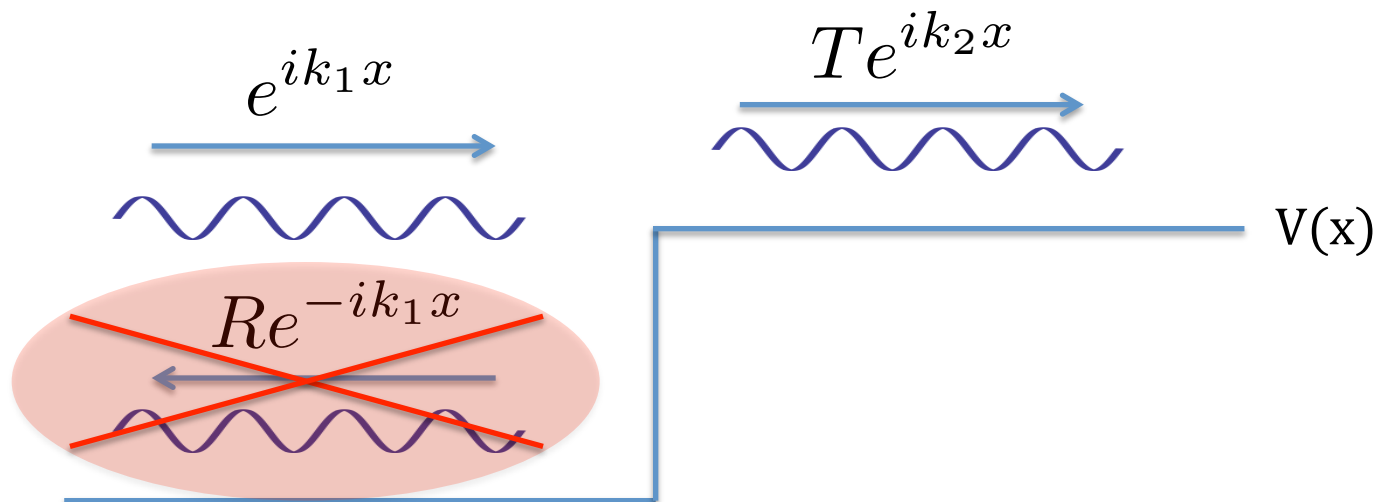



New Method for High-Accuracy Determination of the Fine-Structure Constant Based on Quantized Hall Resistance

K. v. Klitzing

Physikalisches Institut der Universität Würzburg, D-8700 Würzburg, Federal Republic of Germany, and Hochfeld-Magnetlabor des Max-Planck-Instituts für Festkörperforschung, F-38042 Grenoble, France

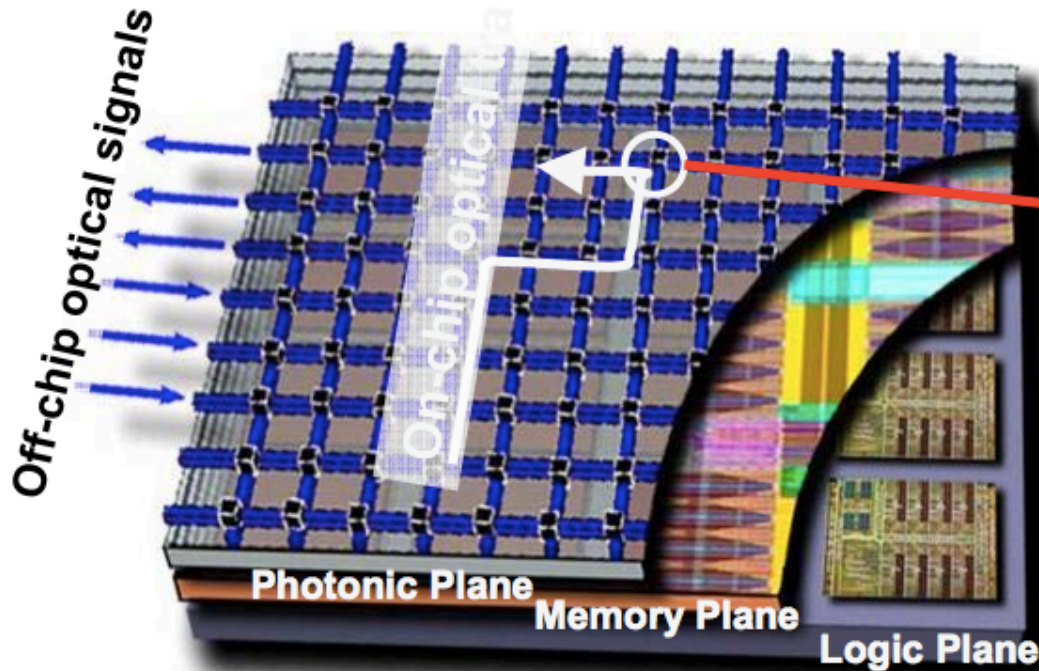

Optical Switch Network

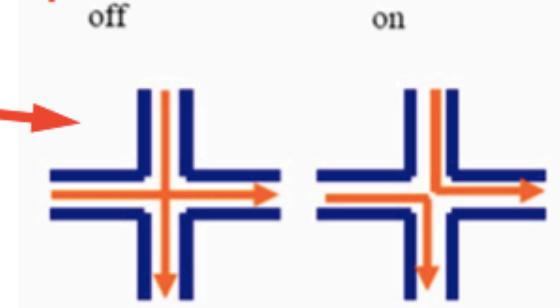

Photonic layer not only connects various cores, but also routes the traffic

Background: photonic topological protection



Raghu, Haldane PRL (2008)

$$\tilde{\mu} = \begin{pmatrix} \mu_1 & i\mu_2 & 0 \\ -i\mu_2 & \mu_1 & 0 \\ 0 & 0 & \mu_1 \end{pmatrix}$$

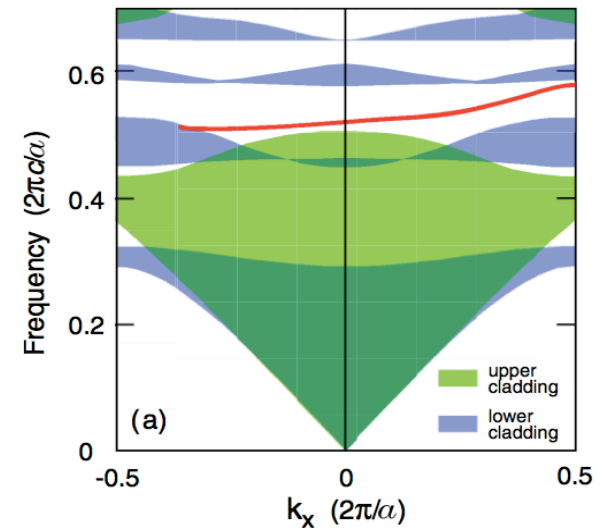

Wang et. al., PRL (2008)

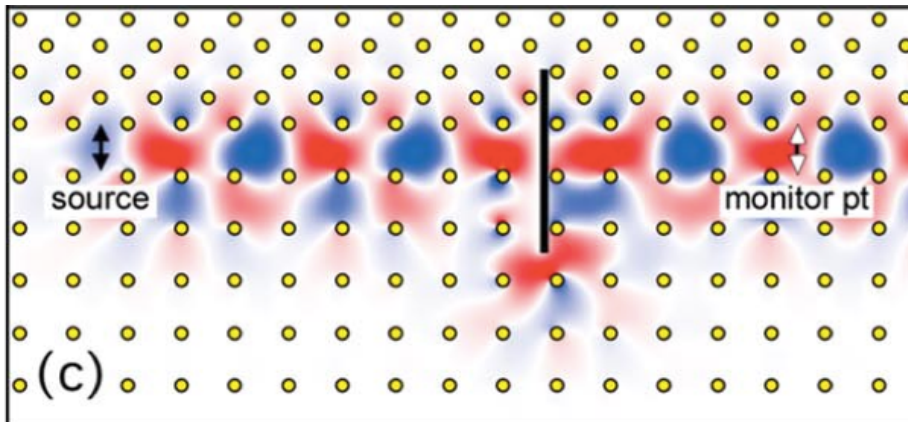

Wang et. al., Nature (2009)

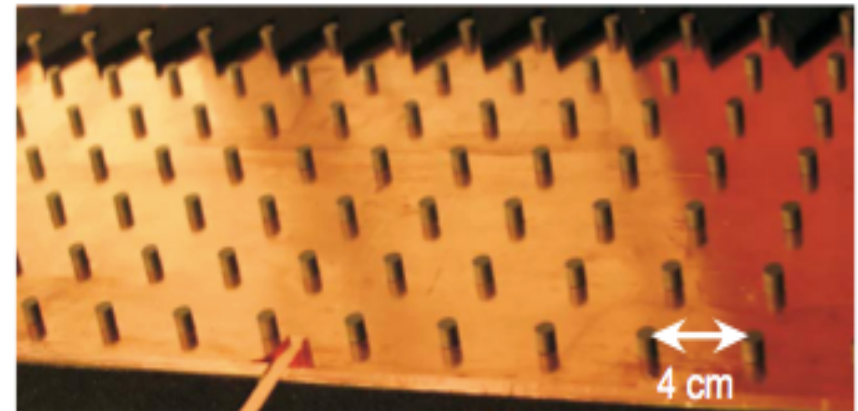



Electrodynamics of Continuous Media

2nd edition

Landau and Lifshitz Course of Theoretical Physics
Volume 8

L.D. Landau, E.M. Lifshitz and L.P. Pitaevskii
Technical Physics, USSR Academy of Sciences Moscow
Translated by J.R. Sykes, J.S. Bell and M.J. Kearsley

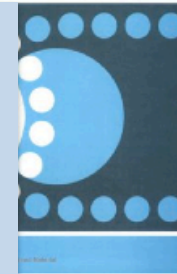

**The big question:
How can we strongly break
time-reversal symmetry
in optics?**

Thus there is
onward, and in
and \mathbf{H} in this frequency range would be an over-temperament. Actually, the same is true for

ical frequencies
ish between \mathbf{B}
the same is true for

Magnetic response is inherently weak at optical frequencies

- (1) Koch, Houck, Le Hur, Girvin, PRA (2010): circuit QED system
- (2) Hafezi, Demler, Lukin, Taylor, Nature Phys. (2011): CROWS [+ Nature Photon. (2013)]
- (3) Umucalilar and Carusotto, PRA (2011): using spin as polarization in PCs
- (4) Fang, Yu, Fan, Nature Photon. (2012): electrical modulation of refractive index in PCs
- (5) Khanikev et. al. Nature Mat. (2012): birefringent metamaterials

... also in cold atoms

Experimental system: photonic lattices



Array of coupled waveguides

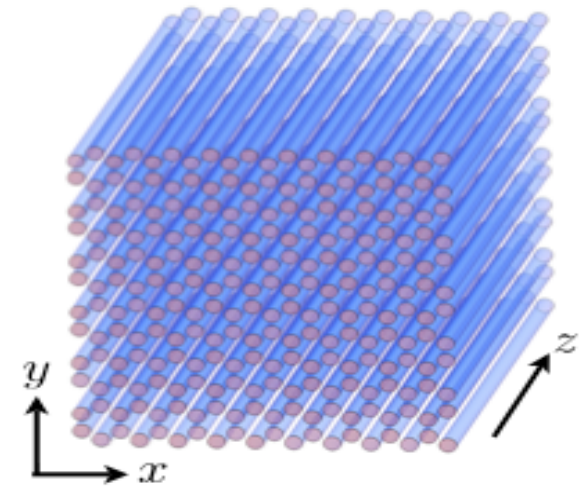
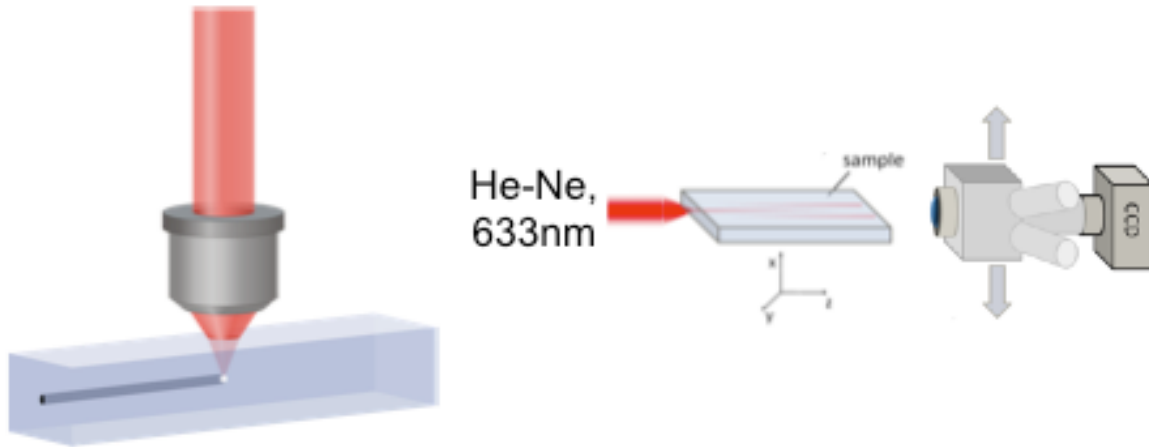

Peleg et. al., PRL (2007)

Envelope approximation for electric field:

$$\mathbf{E}(x, y, z) = \hat{x}\psi(x, y, z)e^{i(k_0 z - \omega t)}$$

$$|\partial_z^2 \psi| \ll 2k |\partial_z \psi|$$

Paraxial Schrödinger equation:

$$i\partial_z \psi = -\frac{1}{2k} \nabla^2 \psi - \frac{k}{n_0} \Delta n(x, y, \mathbf{z}) \psi$$

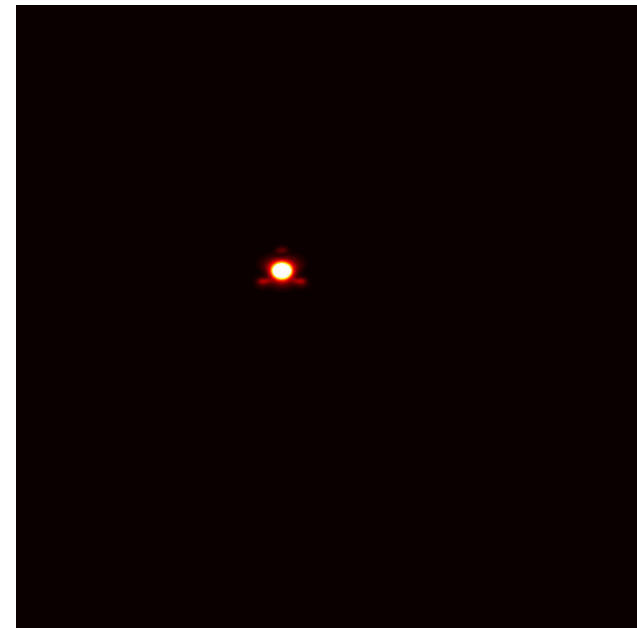

Experimental system: photonic lattices



Our system: topological protection against **transverse** backscattering

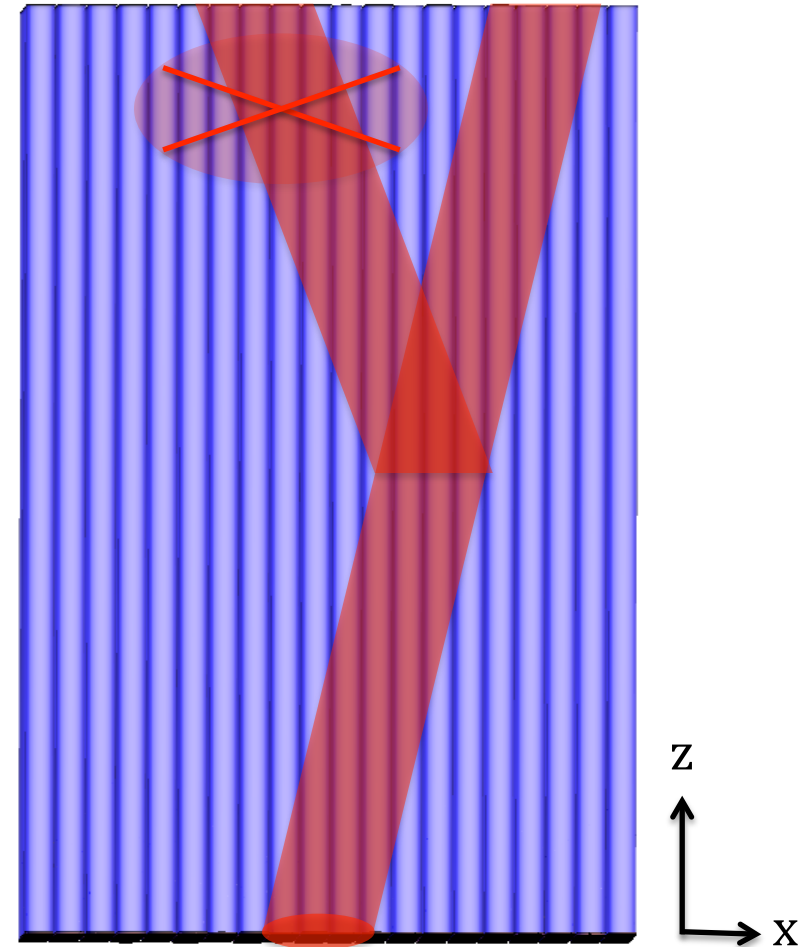
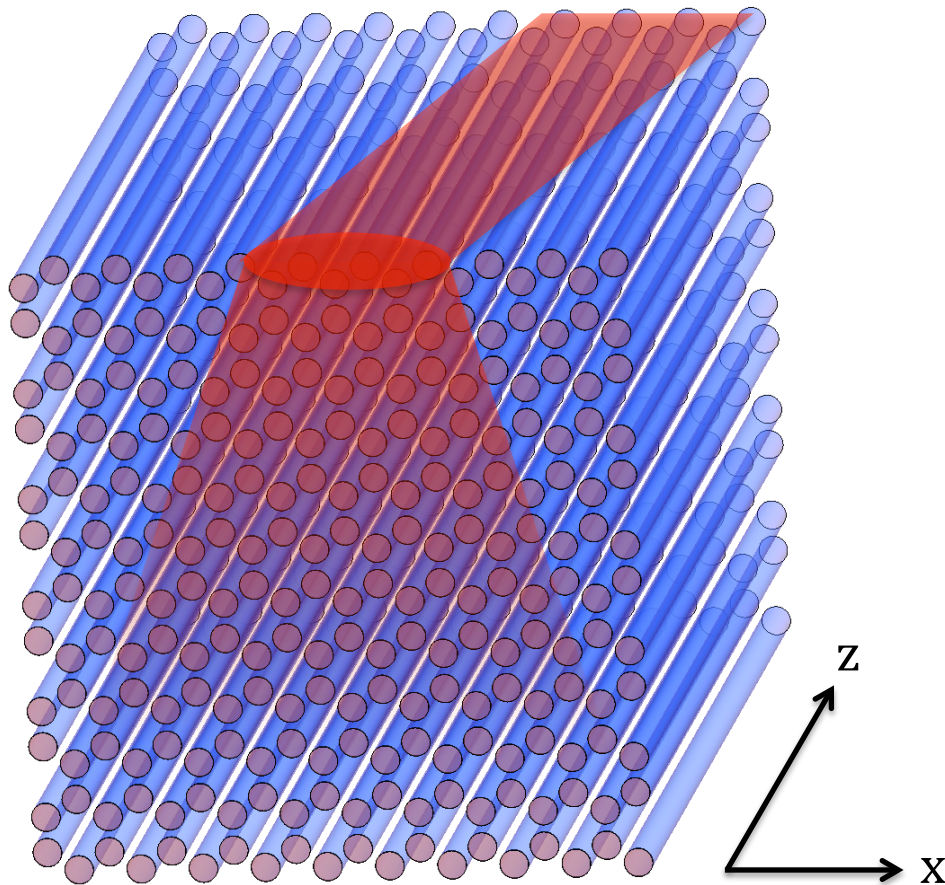

Helical rotation induces a gauge field

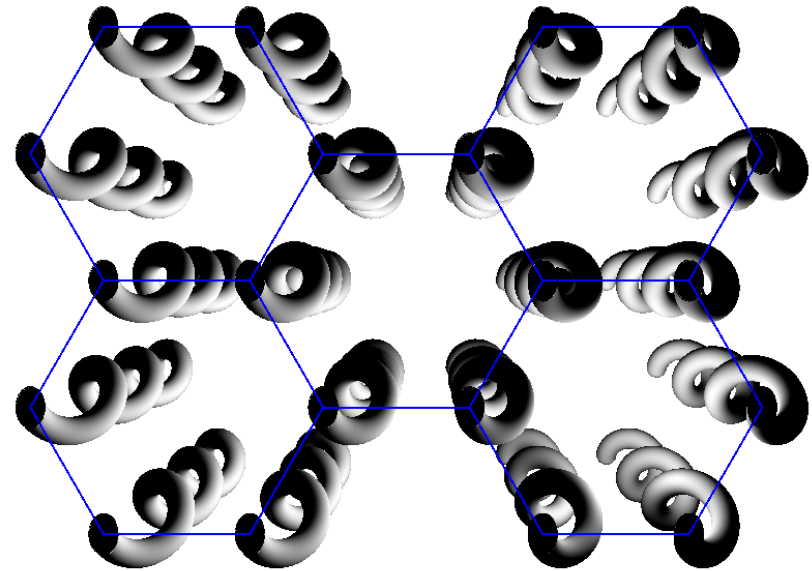
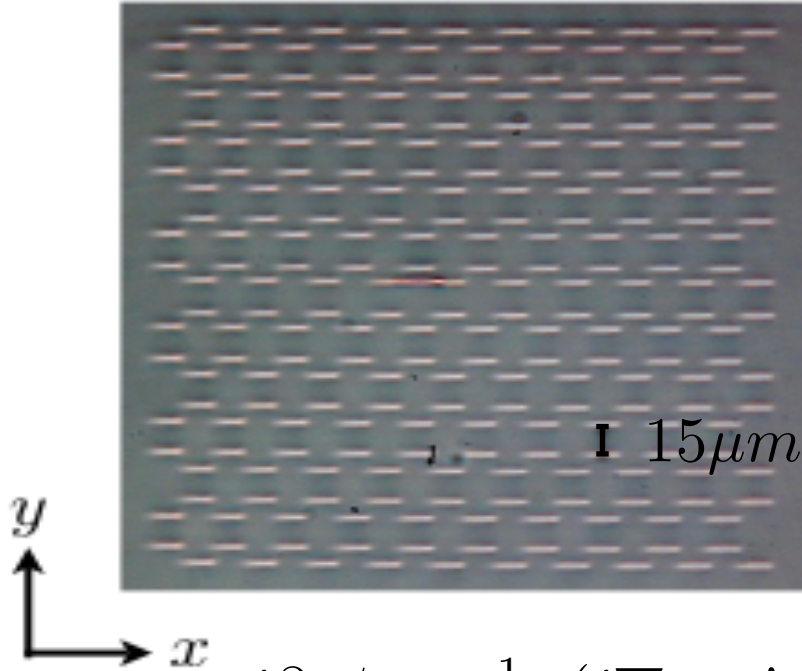

$$i\partial_z\psi = \frac{1}{2k_0} (i\nabla + \mathbf{A}(z))^2 \psi - \frac{k_0\Delta n(x,y)}{n_0} \psi - \frac{k_0 R^2 \Omega^2}{2} \psi$$

$$A(z) = k_0 R \Omega (\sin \Omega z, \cos \Omega z)$$

$$x' = x + R \cos \Omega z$$

$$y' = y + R \sin \Omega z$$

$$z' = z$$

$$\mathcal{H}(z) = \sum_{m, \langle n \rangle} e^{i\mathbf{A}(z) \cdot \mathbf{r}_{mn}} \psi_n^\dagger \psi_m$$

- Floquet TIs: Kitagawa et al., PRB (2010); Lindner et al., Nature Phys. (2011).

Calculating the Floquet band structure



We use Floquet theory (quasiperiodic solutions):

$$\psi_n(z = Z) = e^{-iEZ} \psi_n(z = 0)$$

Calculate the propagator through one period, Z :

$$U(Z) = \prod_z e^{-iH(z)dz}$$

This gives an effective Floquet Hamiltonian:

$$\mathbf{H}_F = \frac{i}{Z} \log U(Z)$$

Graphene opens a Floquet gap for helical waveguides

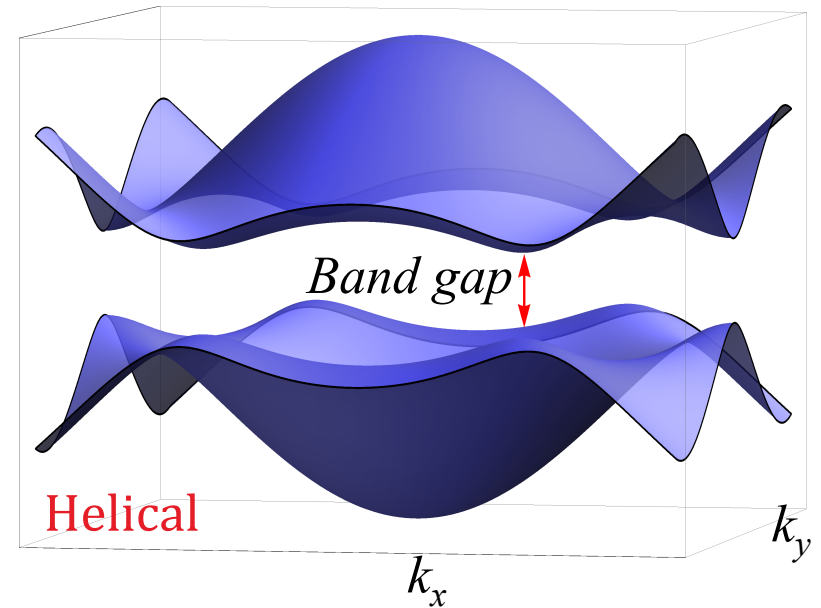
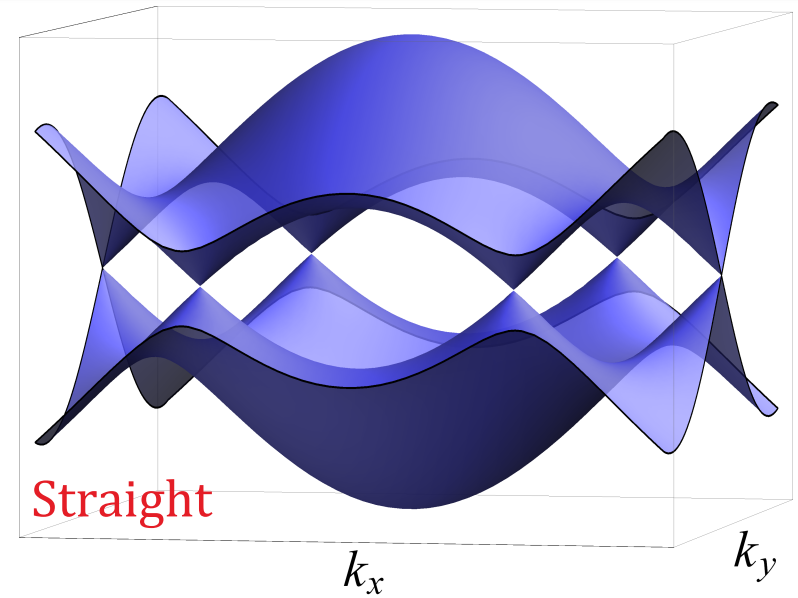
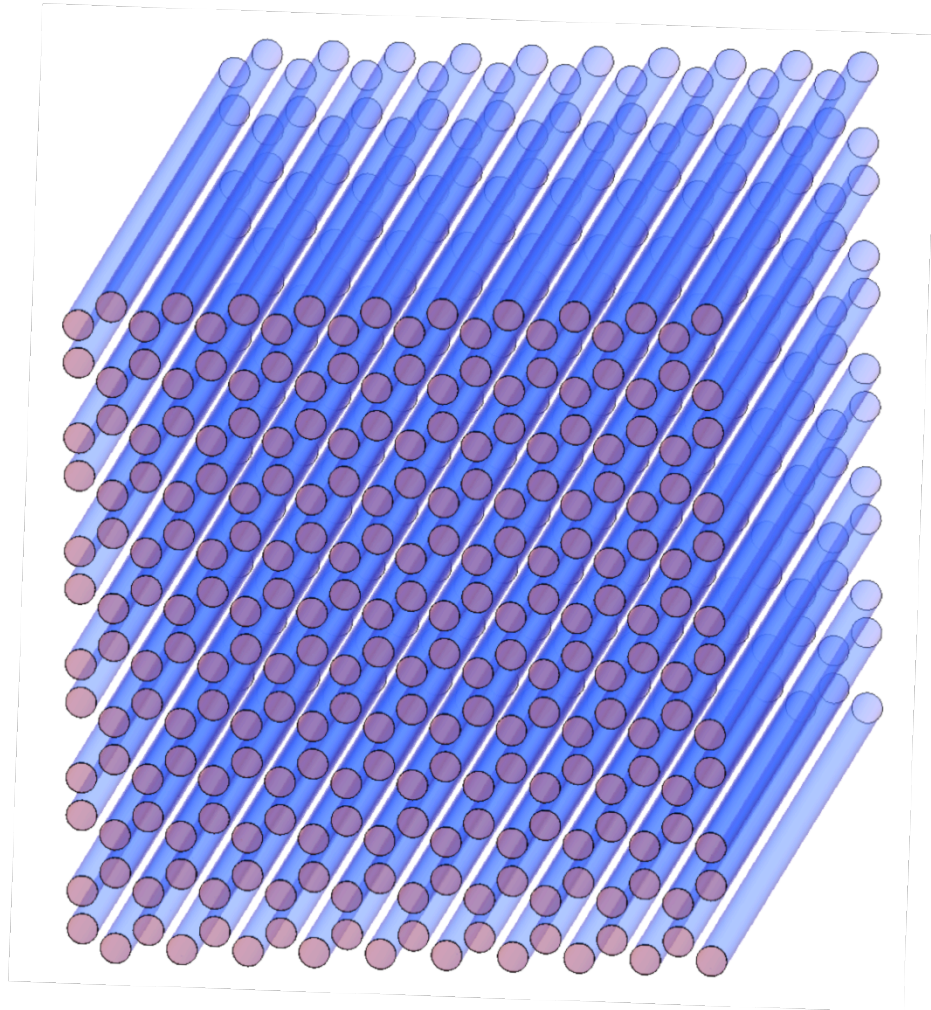

Graphene opens a Floquet gap for helical waveguides

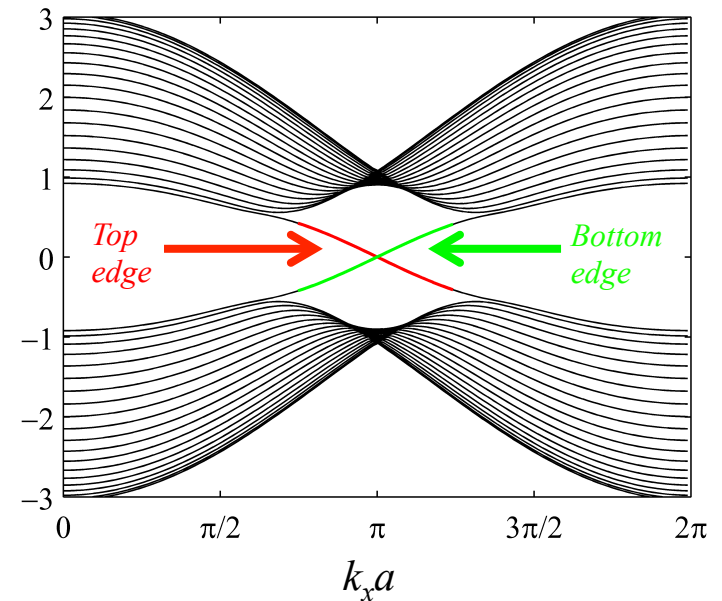
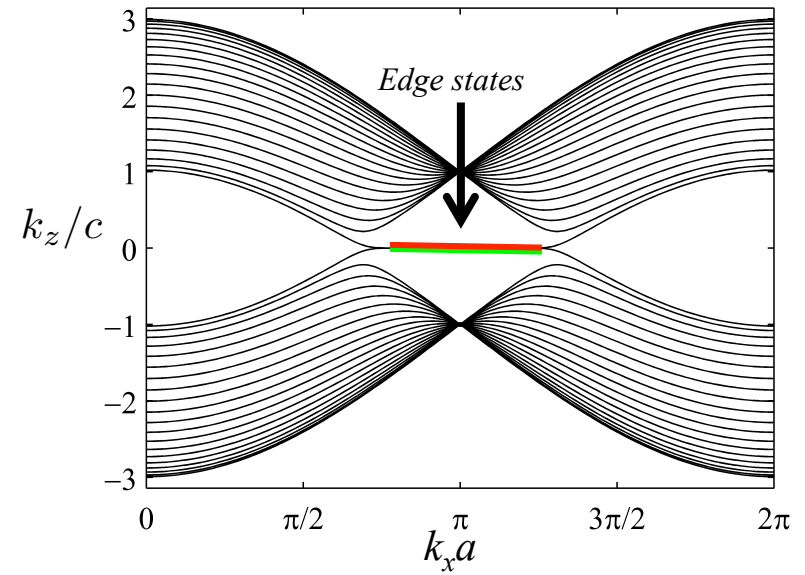
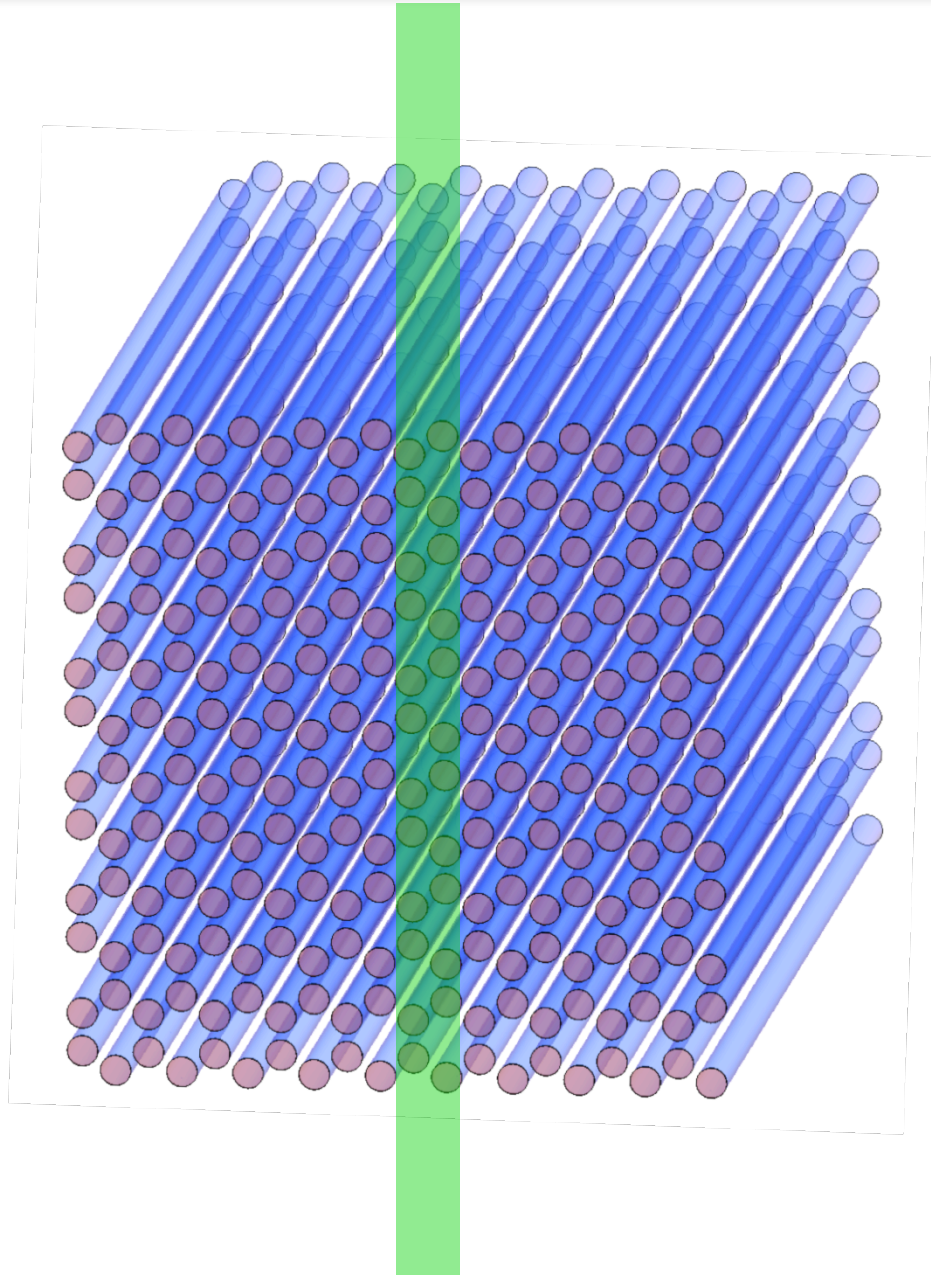

“Time”-domain continuous simulations

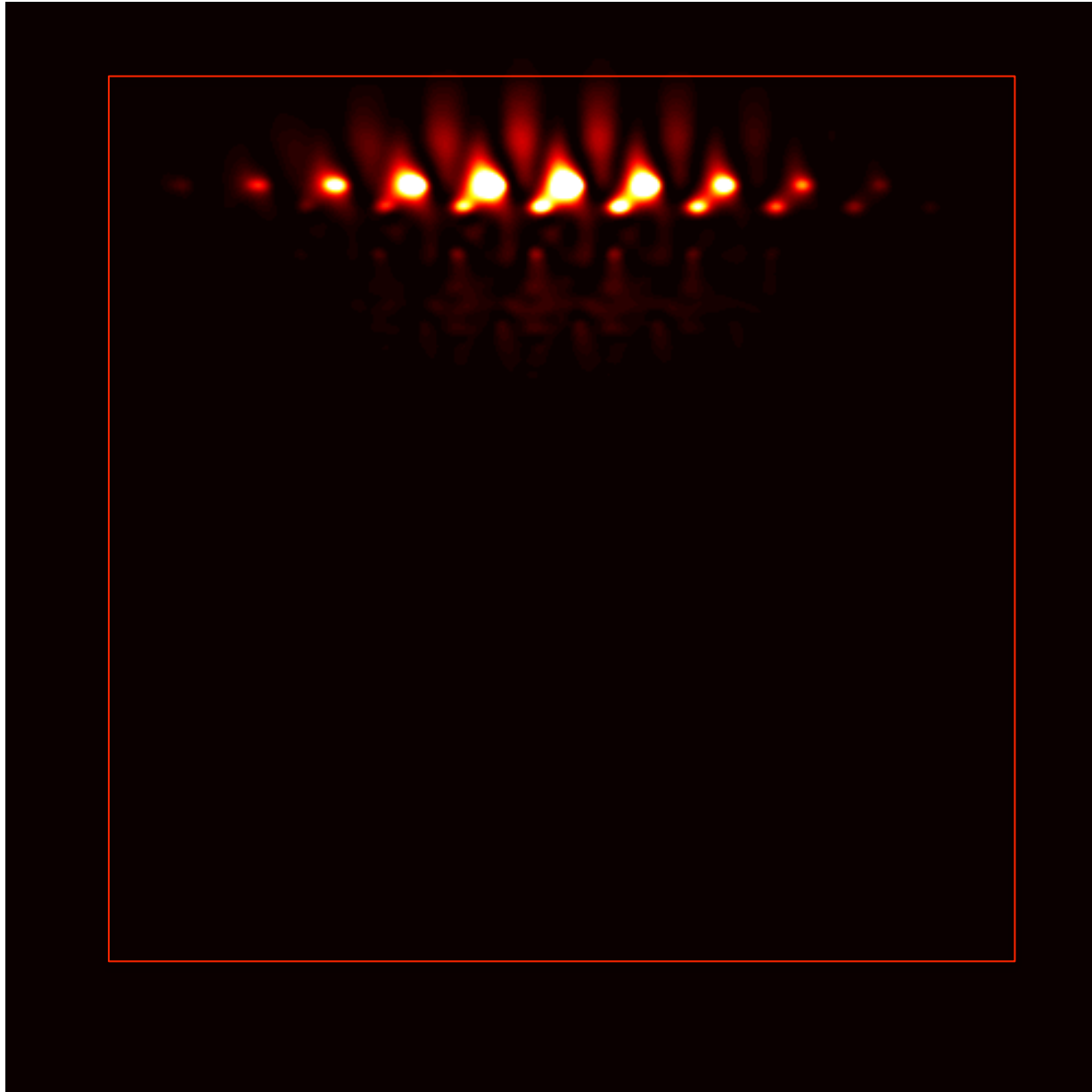

Experimental results: rectangular arrays



Microscope image

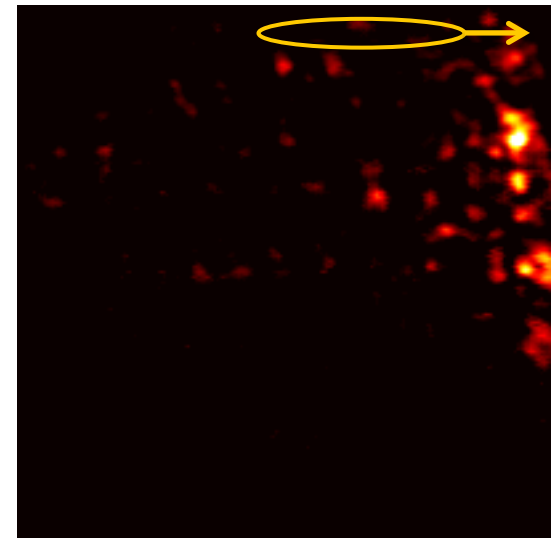
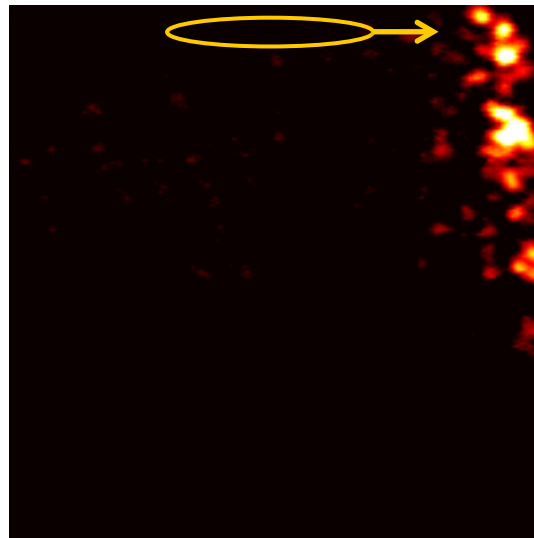
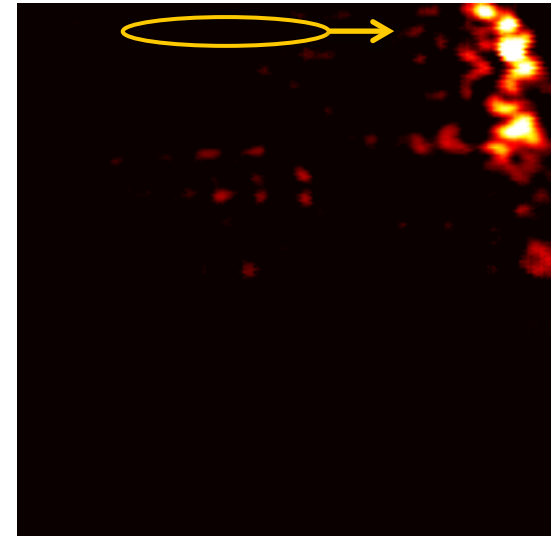
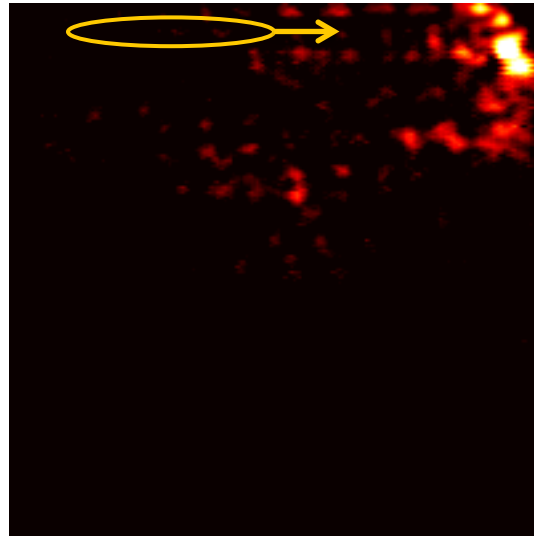
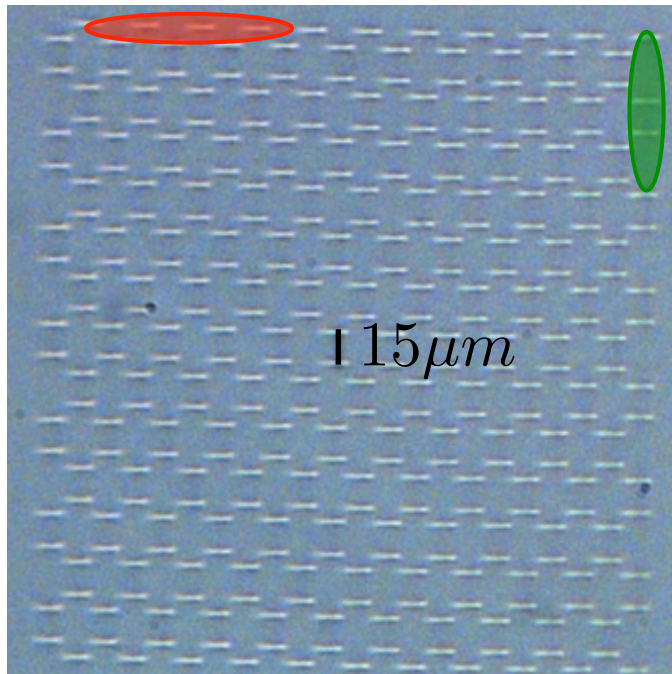

Experimental results: group velocity vs. helix radius, R

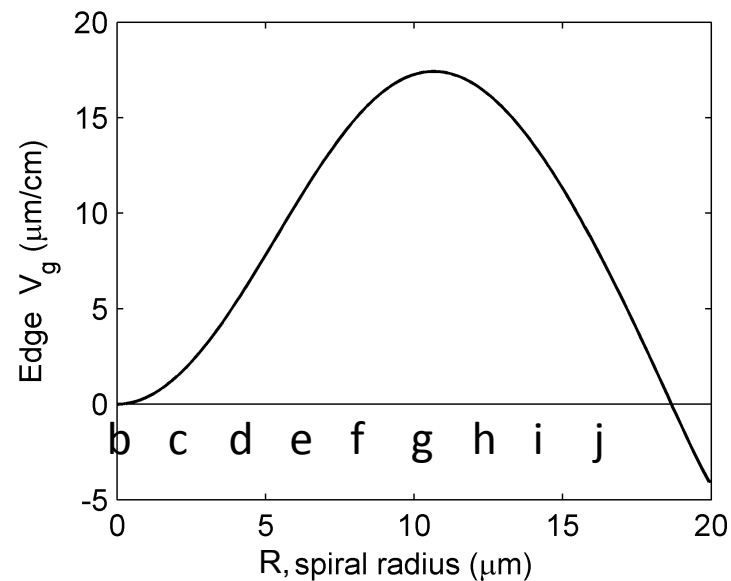
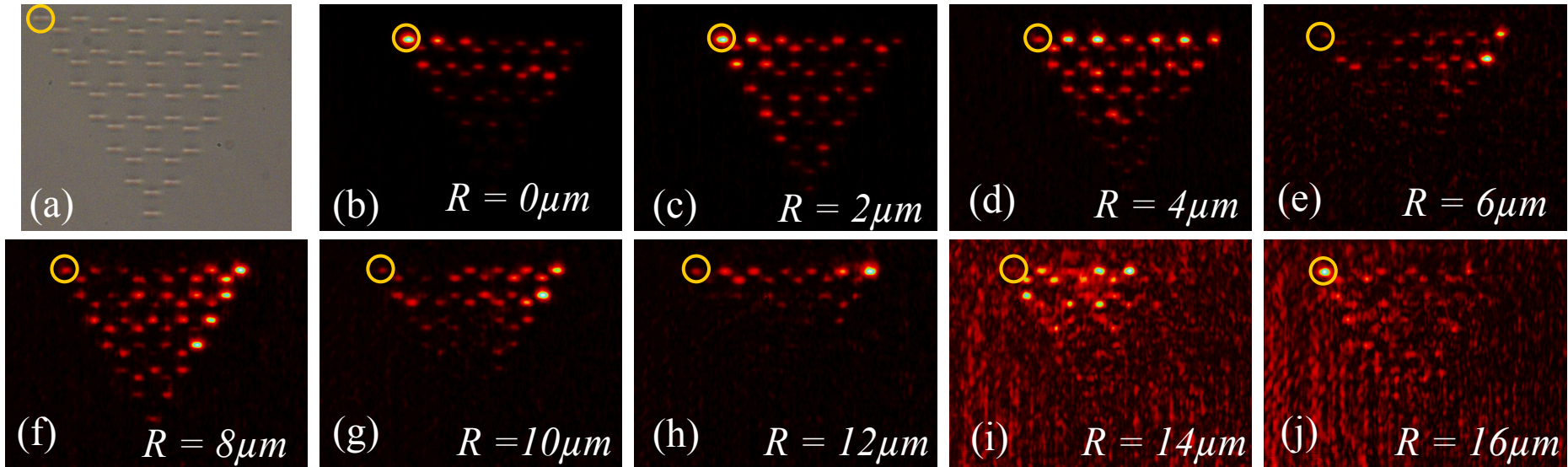

Experimental results: triangular arrays with defects

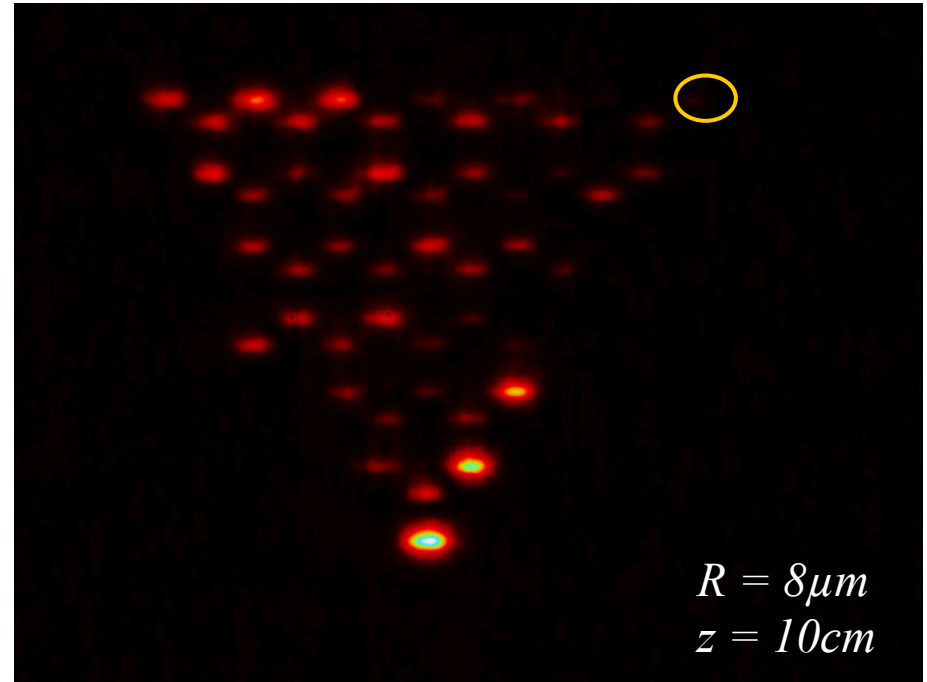
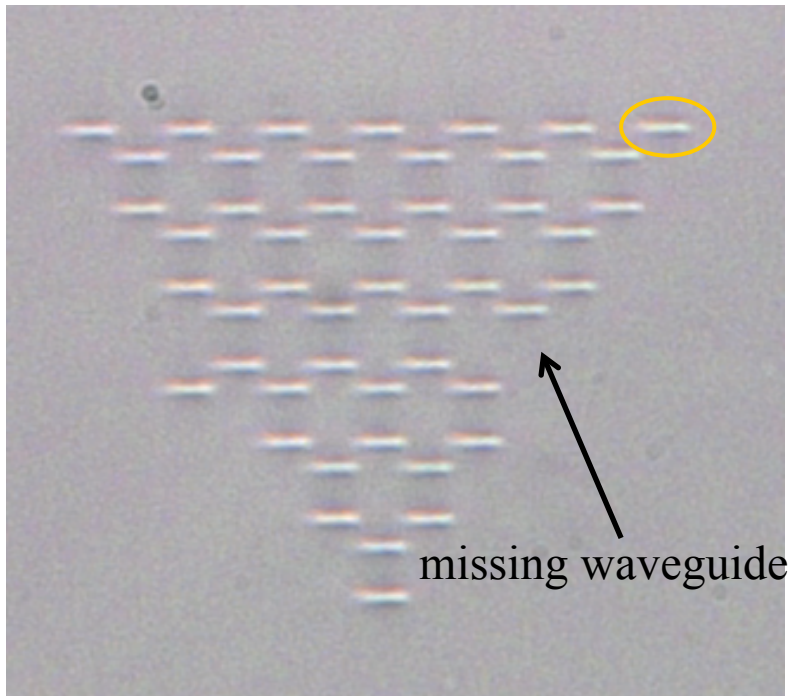

Numerics: topological states in quasicrystals

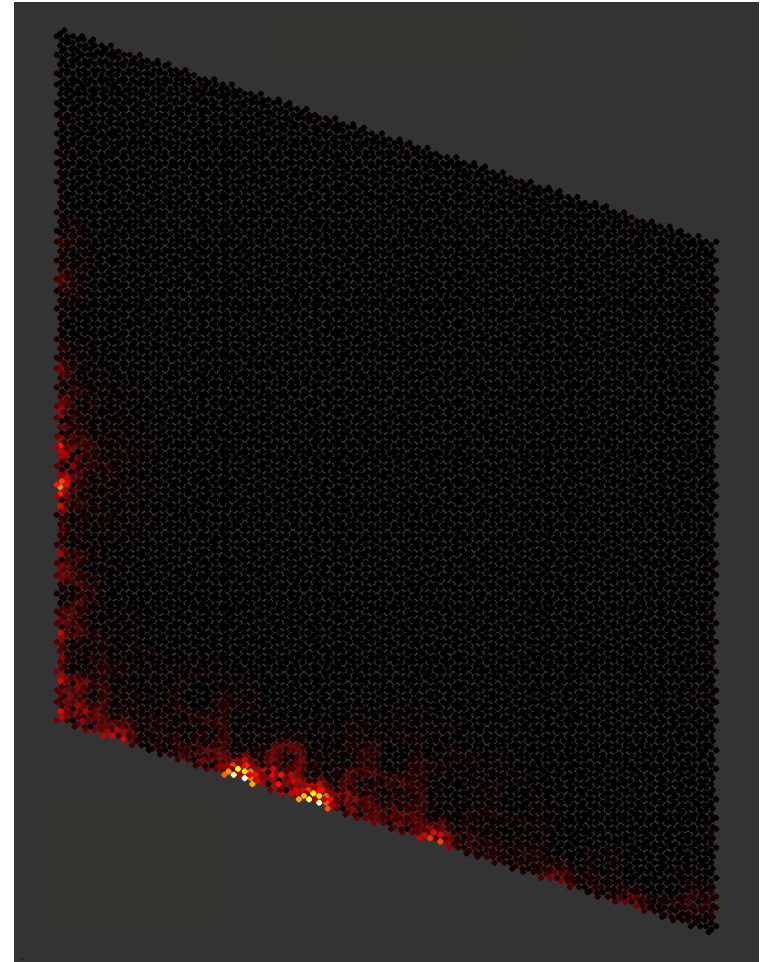
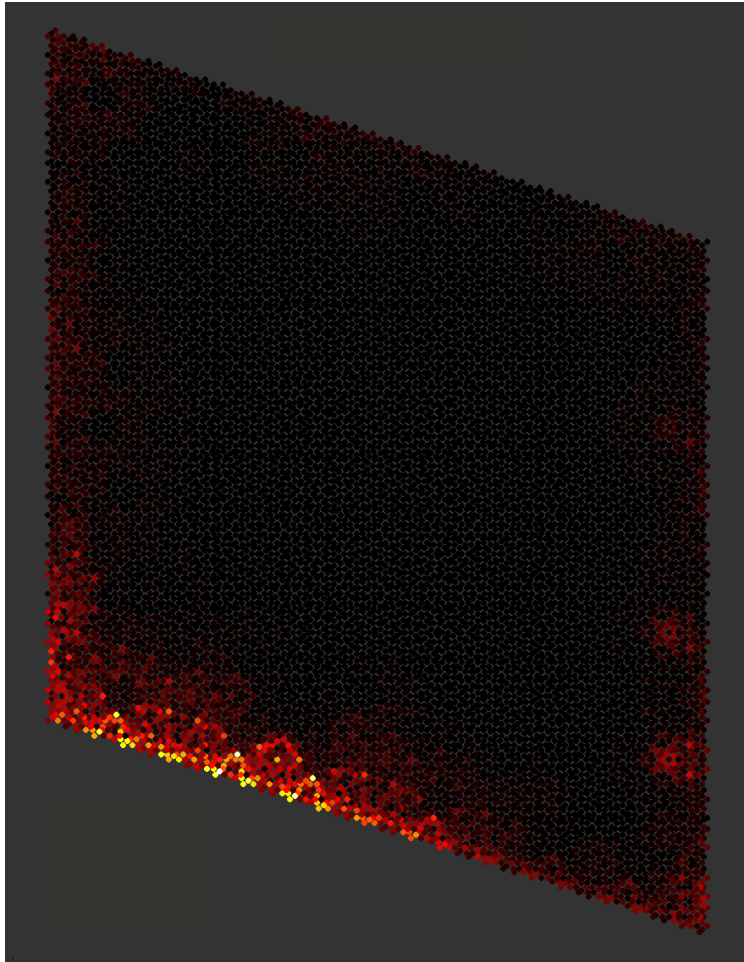

Nonlinearity yields topological solitons

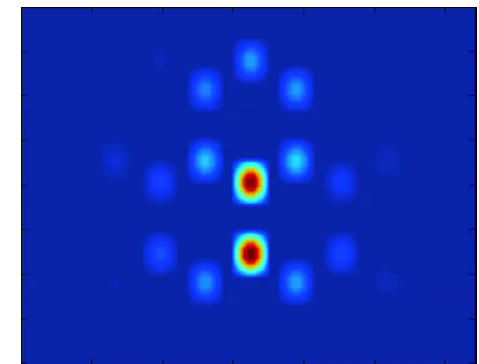
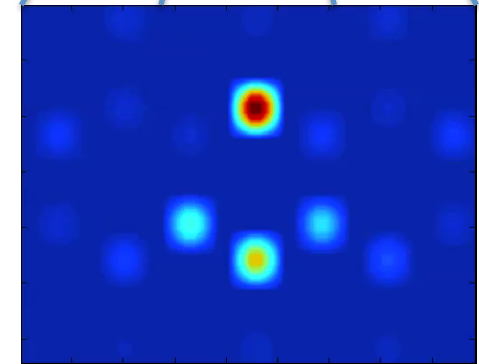
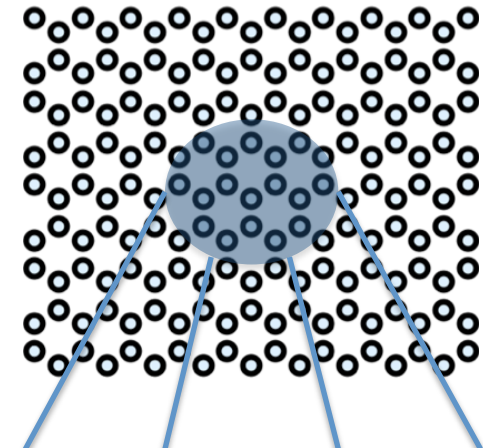
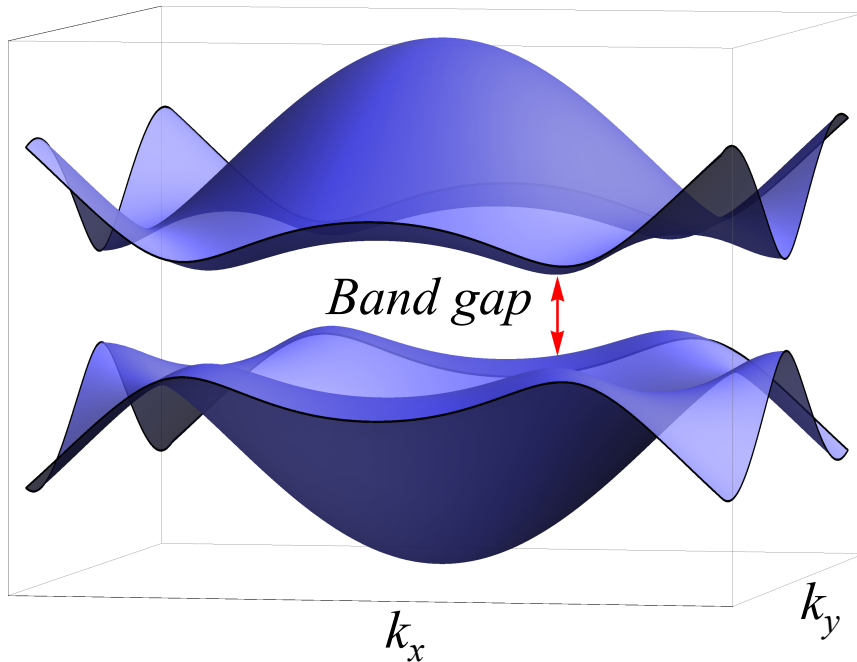

$$i\partial_z\psi_n = \sum_{\langle m \rangle} H_{nm}\psi_m \pm |\psi_n|^2\psi_n$$

Y. Lumer, Y. Plotnik, M. Rechtsman, M. Segev,
Phys. Rev. Lett., 111, 243905 (2013).

Part 2: Experimental observation of optical Weyl points

(collaboration with Chong group, NTU-Singapore and Chen group, Pittsburgh)
Noh et al., Nature Physics (online, 2017)

Some more background on Dirac points

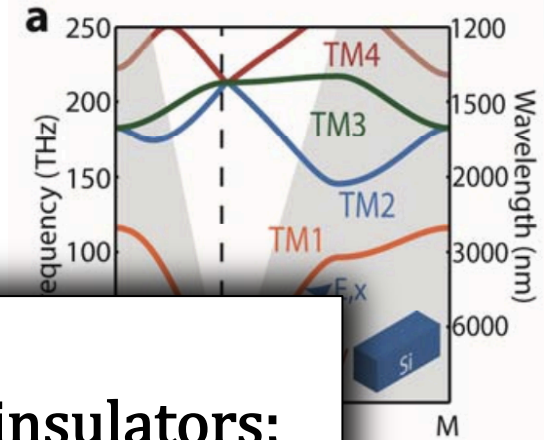
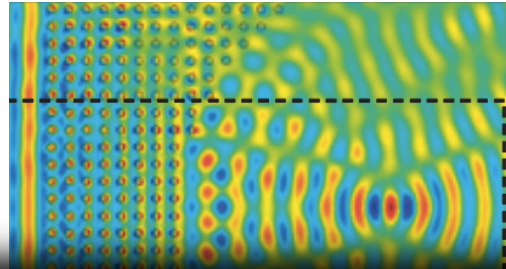
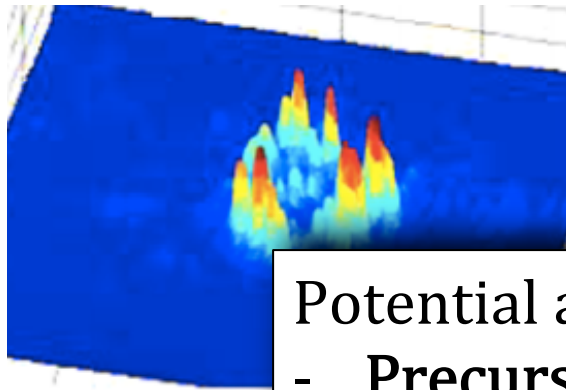

Potential applications in 2D:

- Precursor to photonic topological insulators;
- ENZ Materials;
- Large-area single-mode lasers
- Exceptional rings and photonic tachyons...

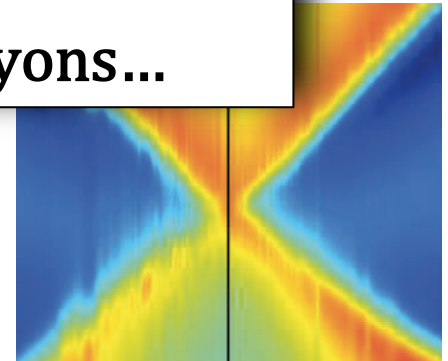
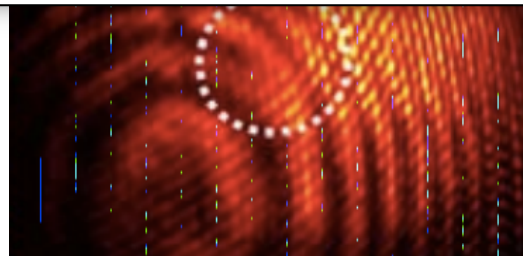
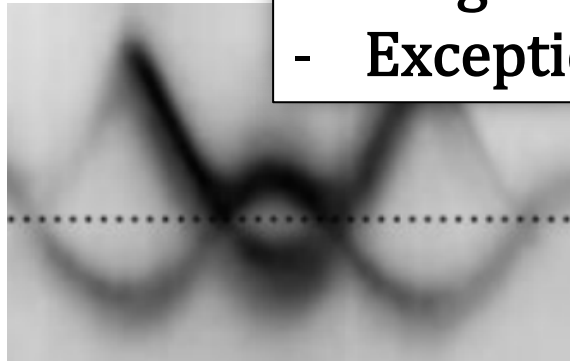

Jacqmin et al., PRL 112, 116402 (2014): Bloch/Amo group

Song et al., Nat. Comm. 6, 6272 (2014): Z. Chen group

Zhen et al., Nature 525, 354 (2015): Soljacic group

Weyl points: 3d Dirac points

- Amazing properties of graphene arise from its Dirac point:

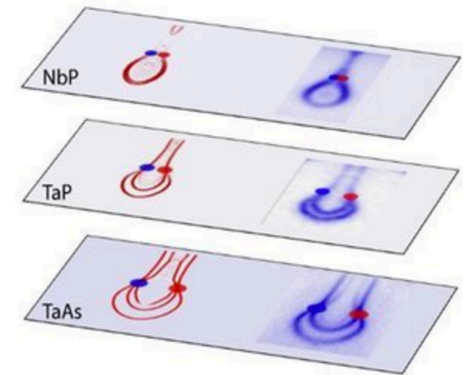
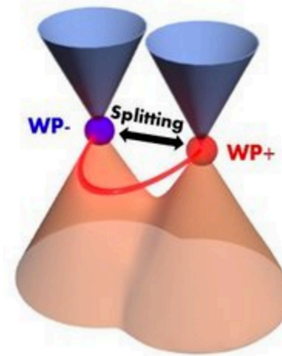
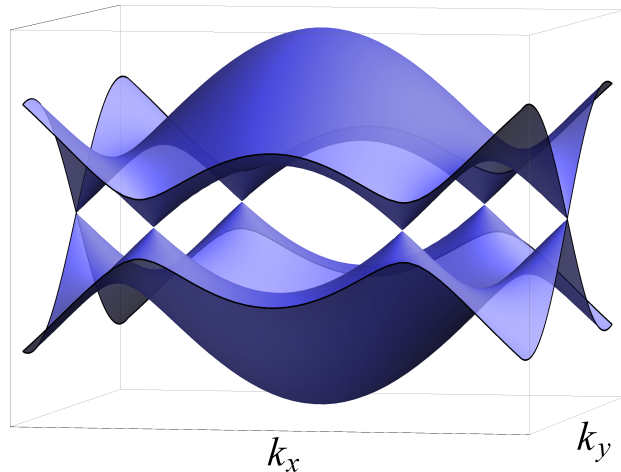

Attribution: Max Planck for the Science of Light, press release

$$H = k_x \sigma_x + k_y \sigma_y + \underbrace{k_z \sigma_z}$$

- In 3d, Weyl point cannot be lifted!
- Associated with magnetic monopole of the Berry curvature.
- Novel behavior in condensed matter systems (Fermi arcs, ...)
- Associated with a topological phase transition
- Large-volume single-mode lasing? (Bravo-Abad et al., PNAS: 9761 (2012))

Weyl points: previous work

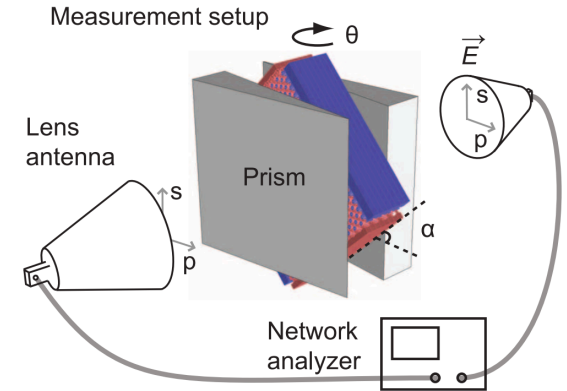
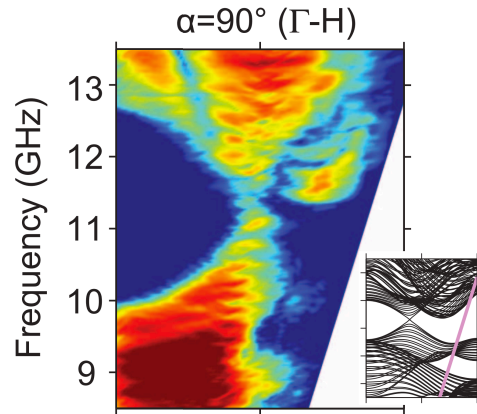
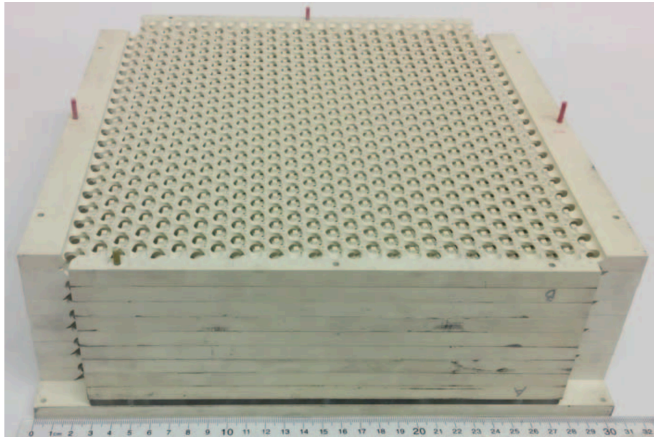

Lu et al., *Science* 349, 622 (2015) [prediction: Lu et al., *Nature Photonics* 7, 294 (2013)]

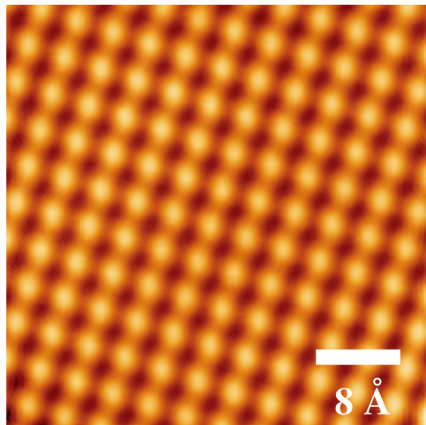
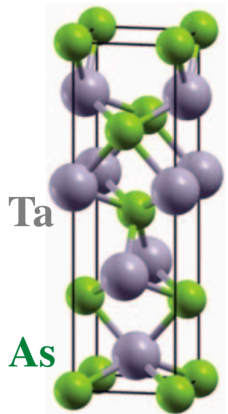

Xu et al., *Science* 349, 613 (2015)

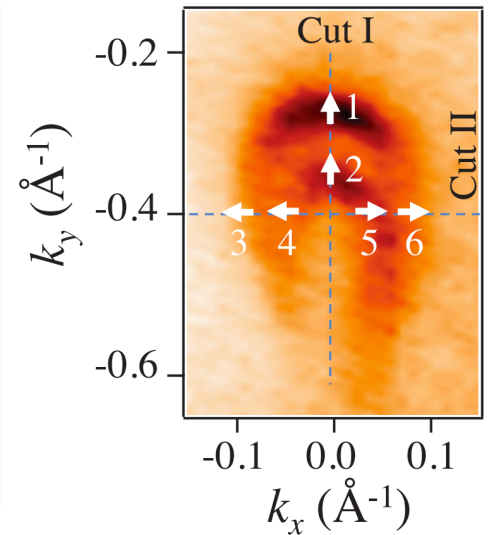
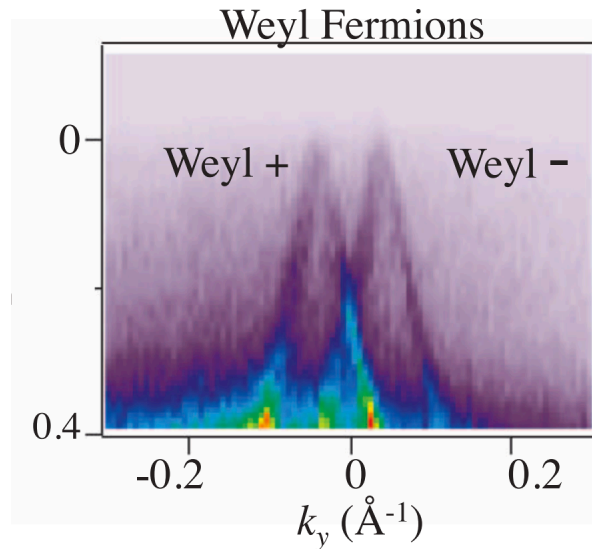

Weyl points: previous work in photonics

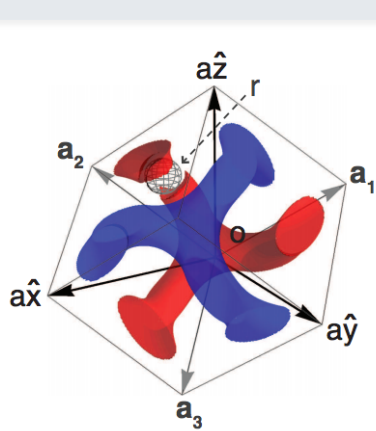

Lu et al., *Nat. Photon* 7, 294 (2013)

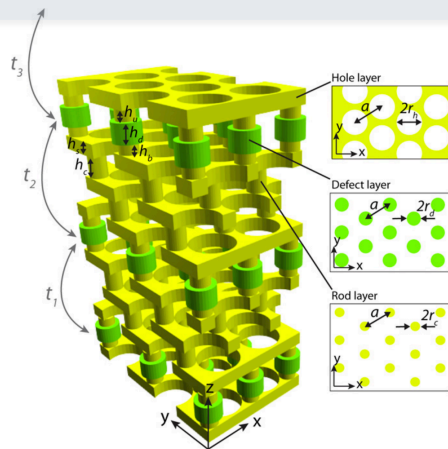

Bravo-Abad et al., *2D Mat.*, 2, 034013 (2015)

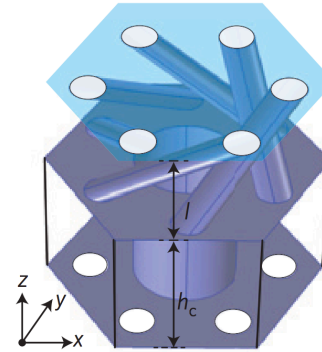

Xiao et al., *Nat. Physics.*, 11, 920 (2015)

- Gao et al., arXiv: 1511.04875 (2015)
- Yang et al., arXiv: 1601.07966 (2015)
- Xiao et al., *PRL*, 117, 057401 (2016)
- Chen et al., arXiv: 1612.04681 (2016)

Also, 3D topological insulators: Lu et al., (Soljacic group) *Nat. Phys.* 12, 337 (2016); Slobzhanyuk et al. (Khanikaev group), *Nat. Photon.* 11, 130 (2017)

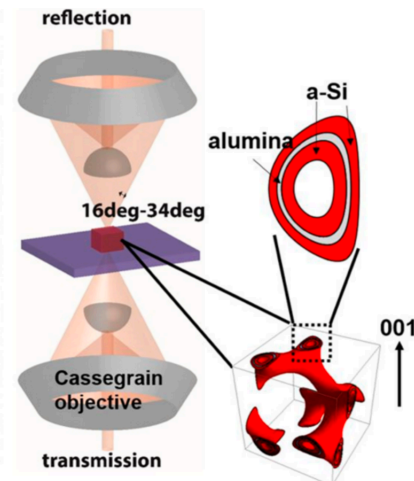
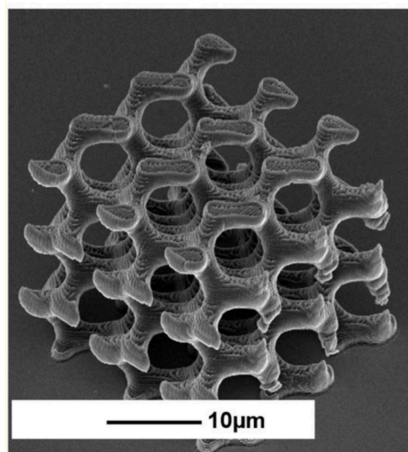

Progress towards mid-infrared Weyl points:

- Peng et al, APS-MM H1.00296 (2015)
- Peng et al., APS-MM S52.00013 (2016)
- Goi et al., CLEO, JTu5A.101 (2015)
- Goi et al., CLEO-2016, SM3R.3 (2016)

Peng et al., *ACS Photonics* 3, 1131 (2016)

How can we get Weyl points?

Well... $2 + 1 = 3$.

Our system: photonic TI with a topological transition

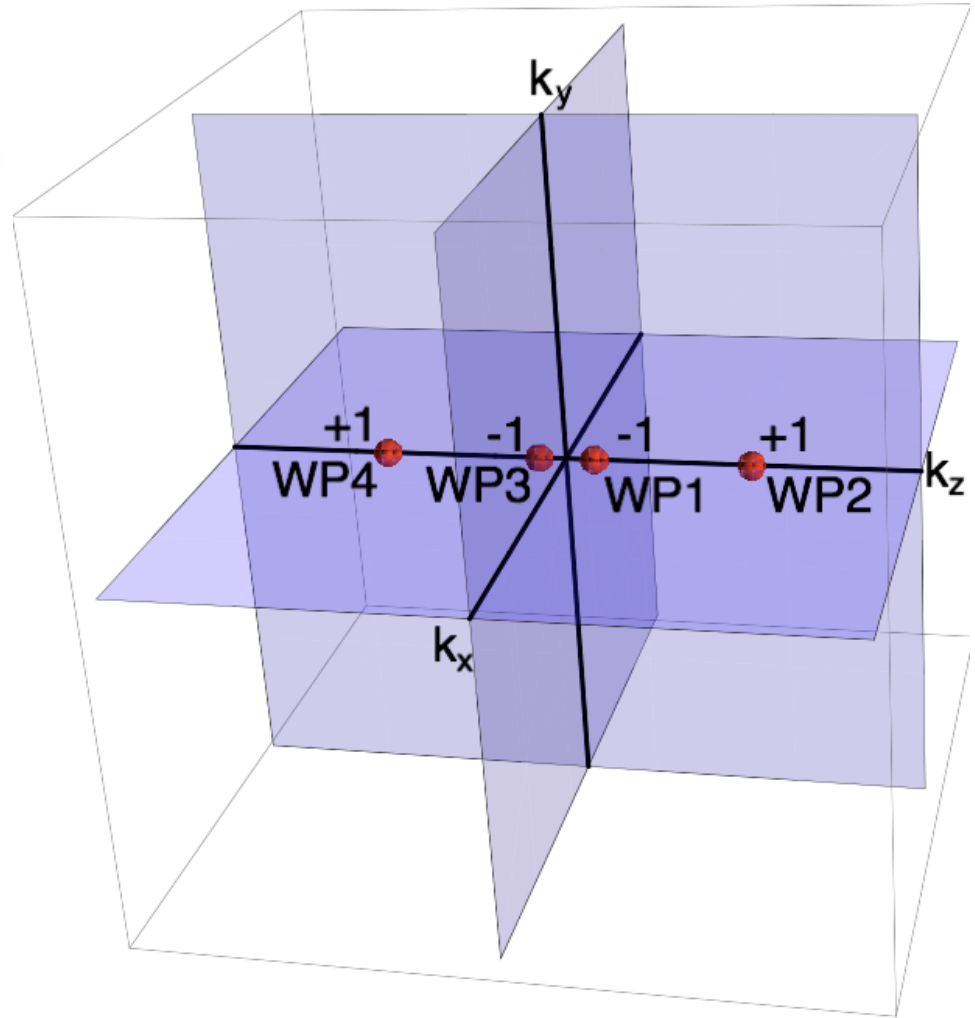
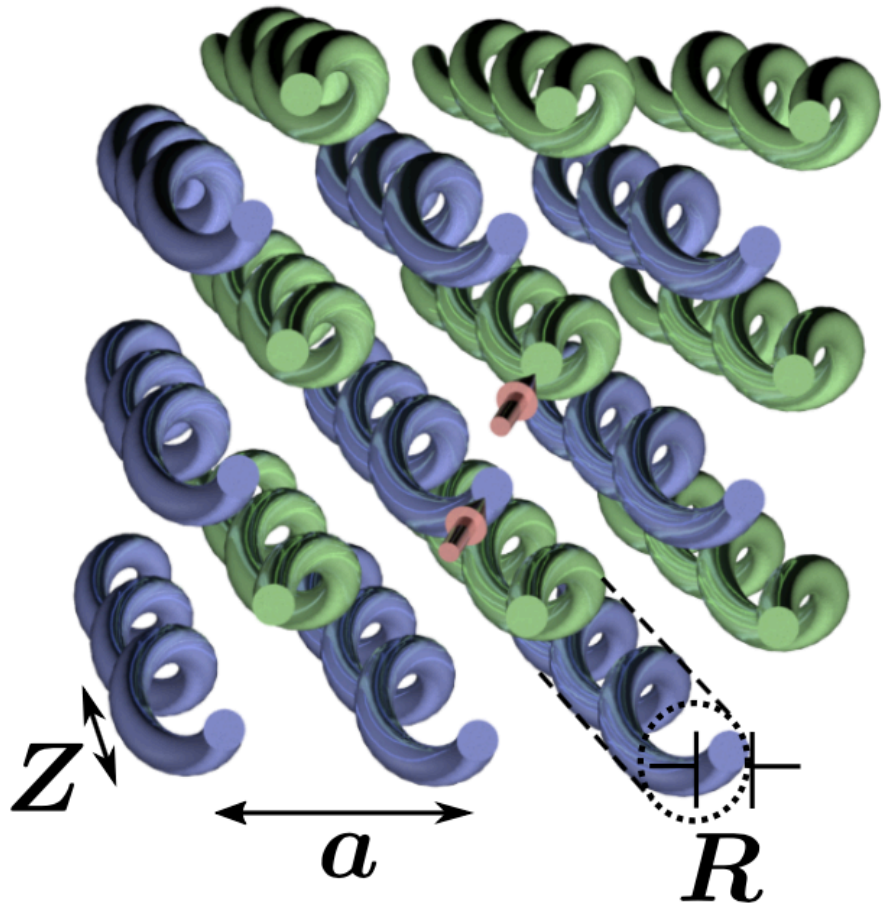

Our system: photonic TI with a topological transition

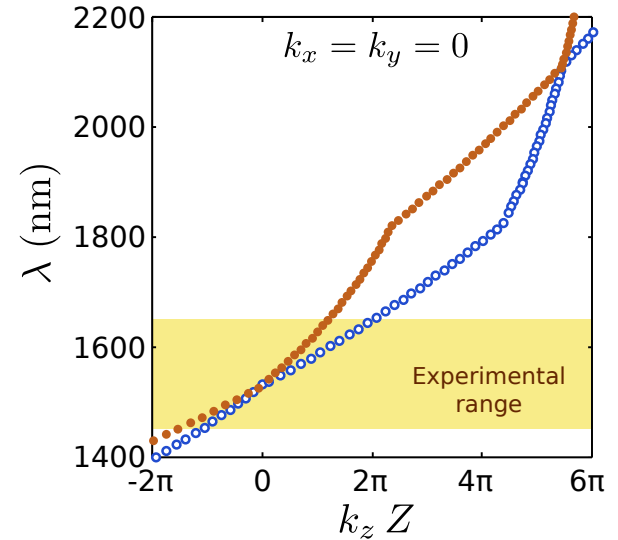
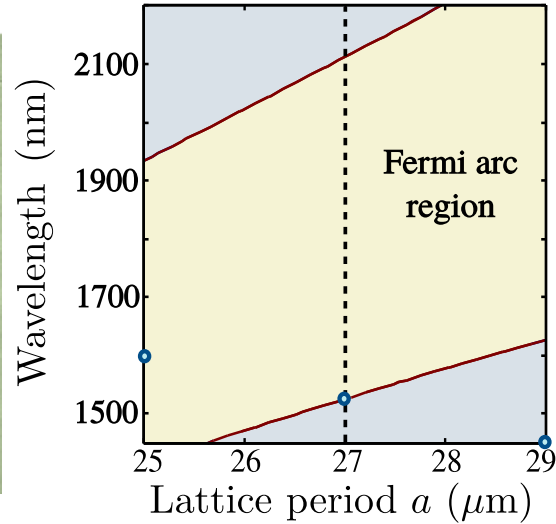

Type-II Weyl points

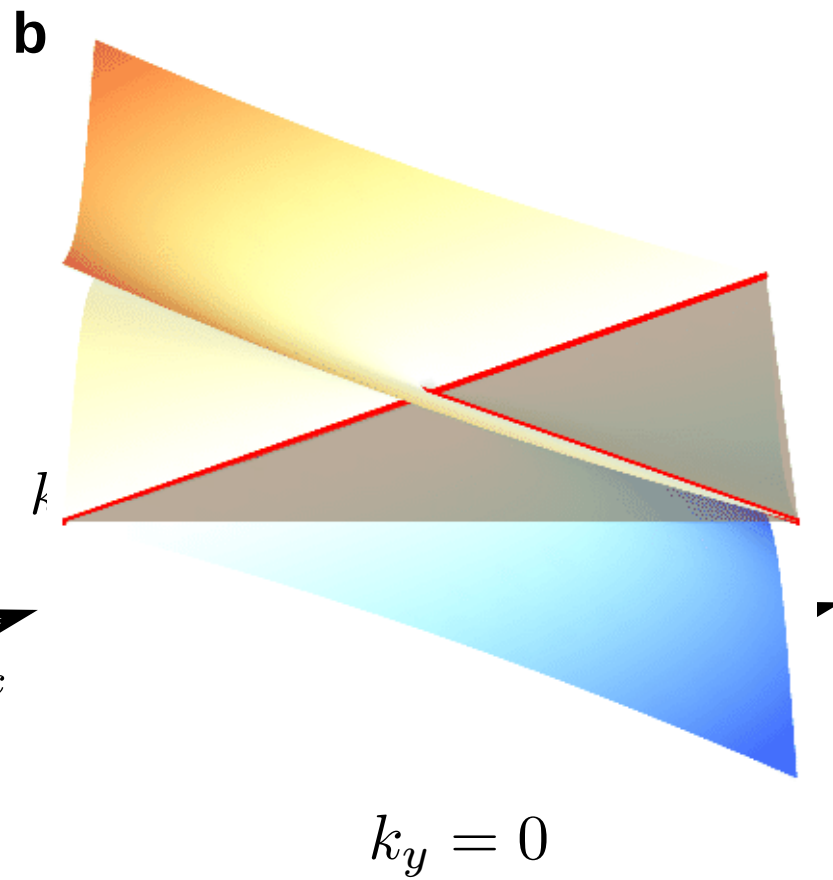
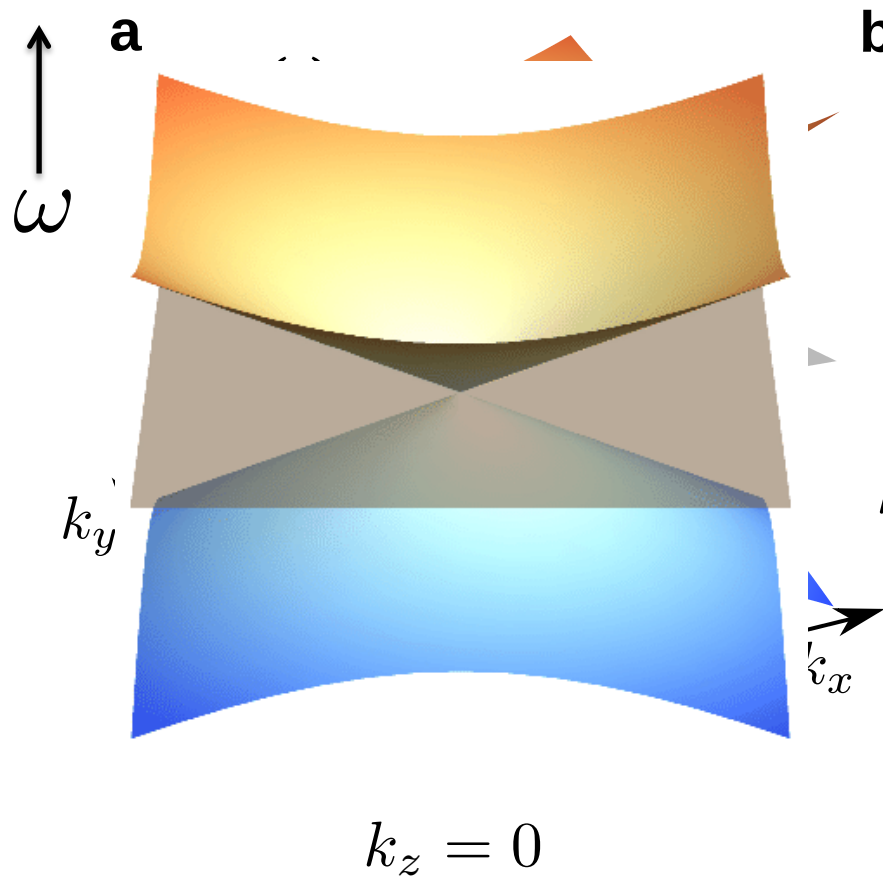

Type-II Weyl points implies conical diffraction

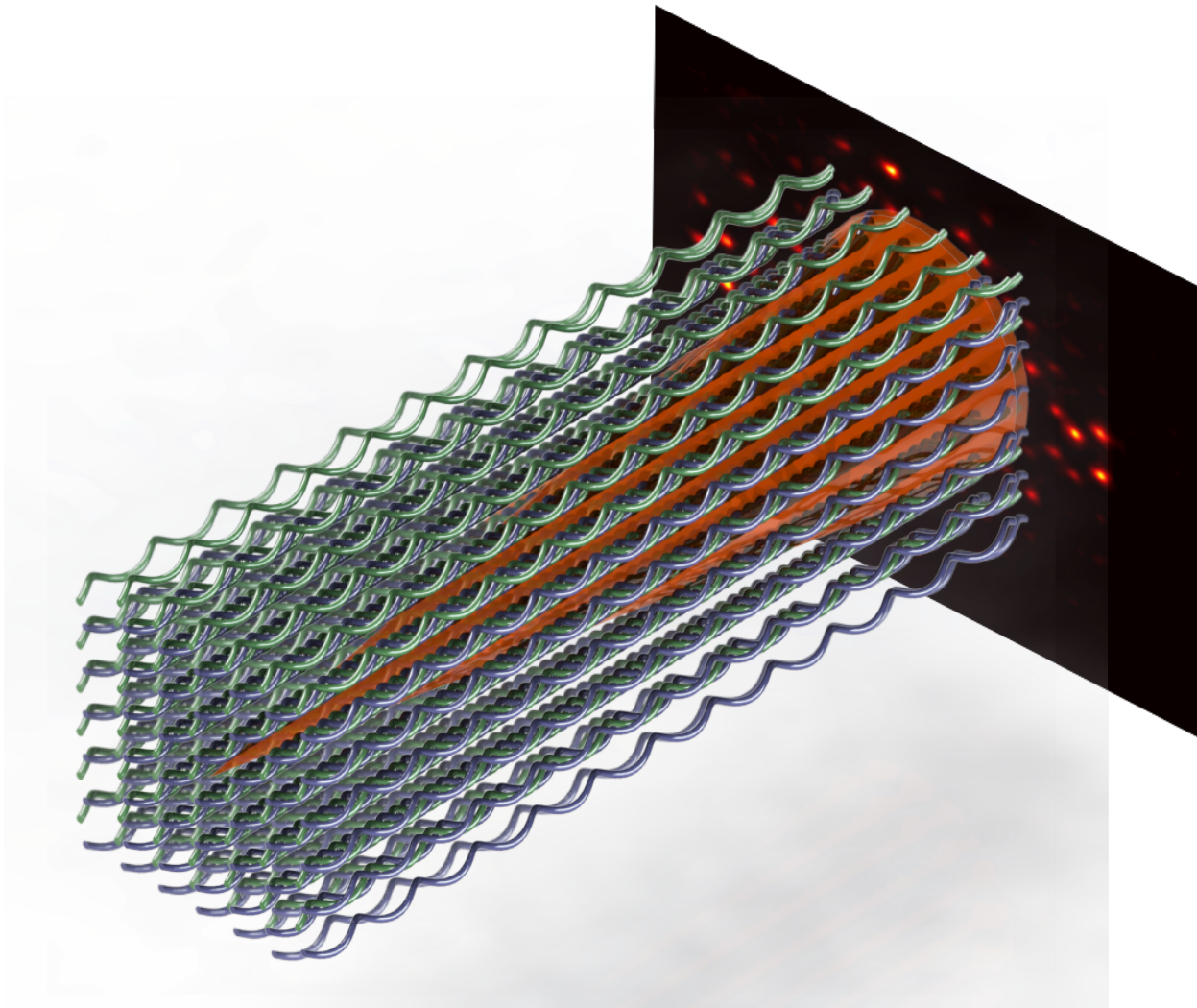

Experimental results: conical diffraction at Weyl point

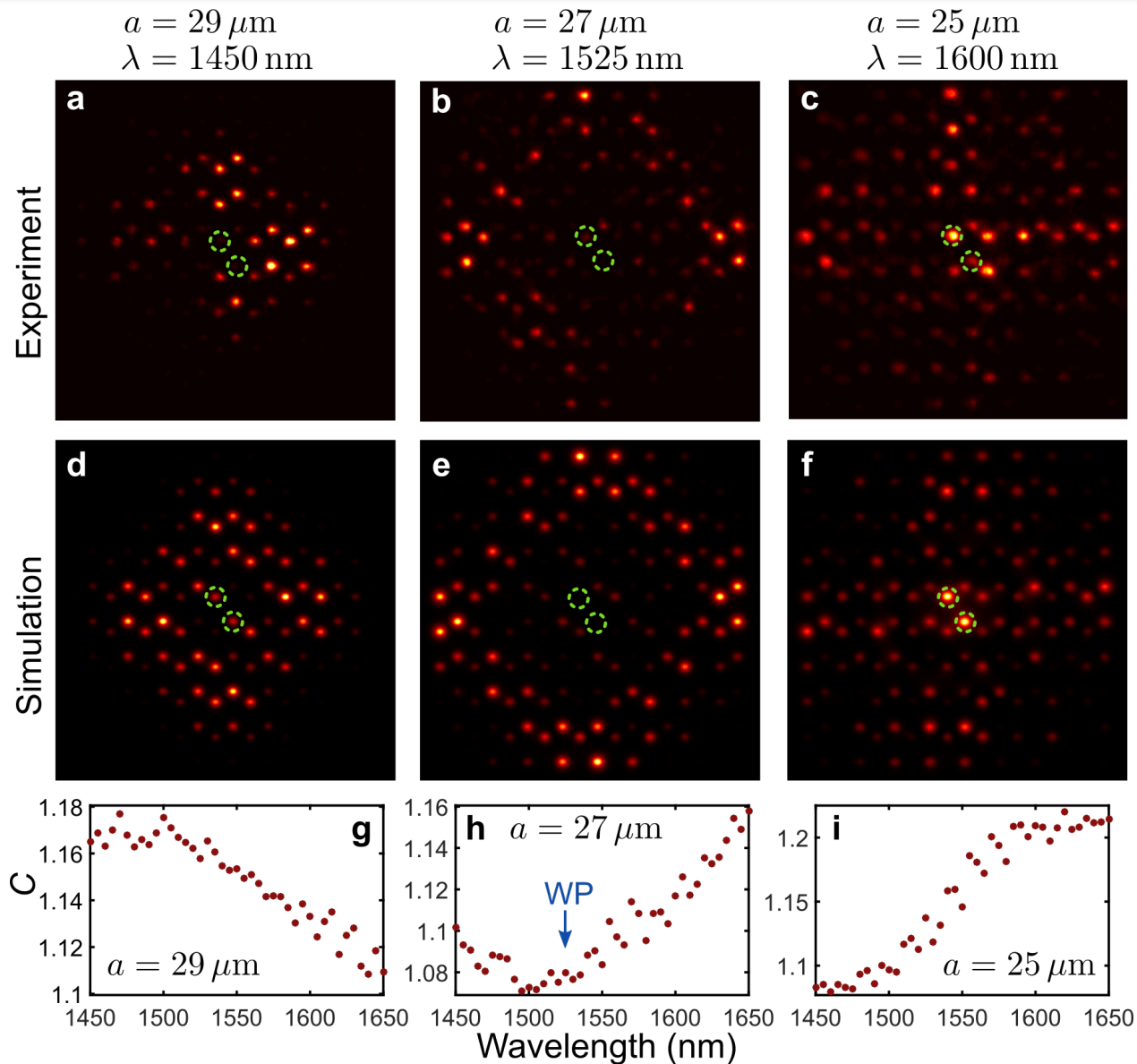

2d edge states are 3d “Fermi arc” surface states

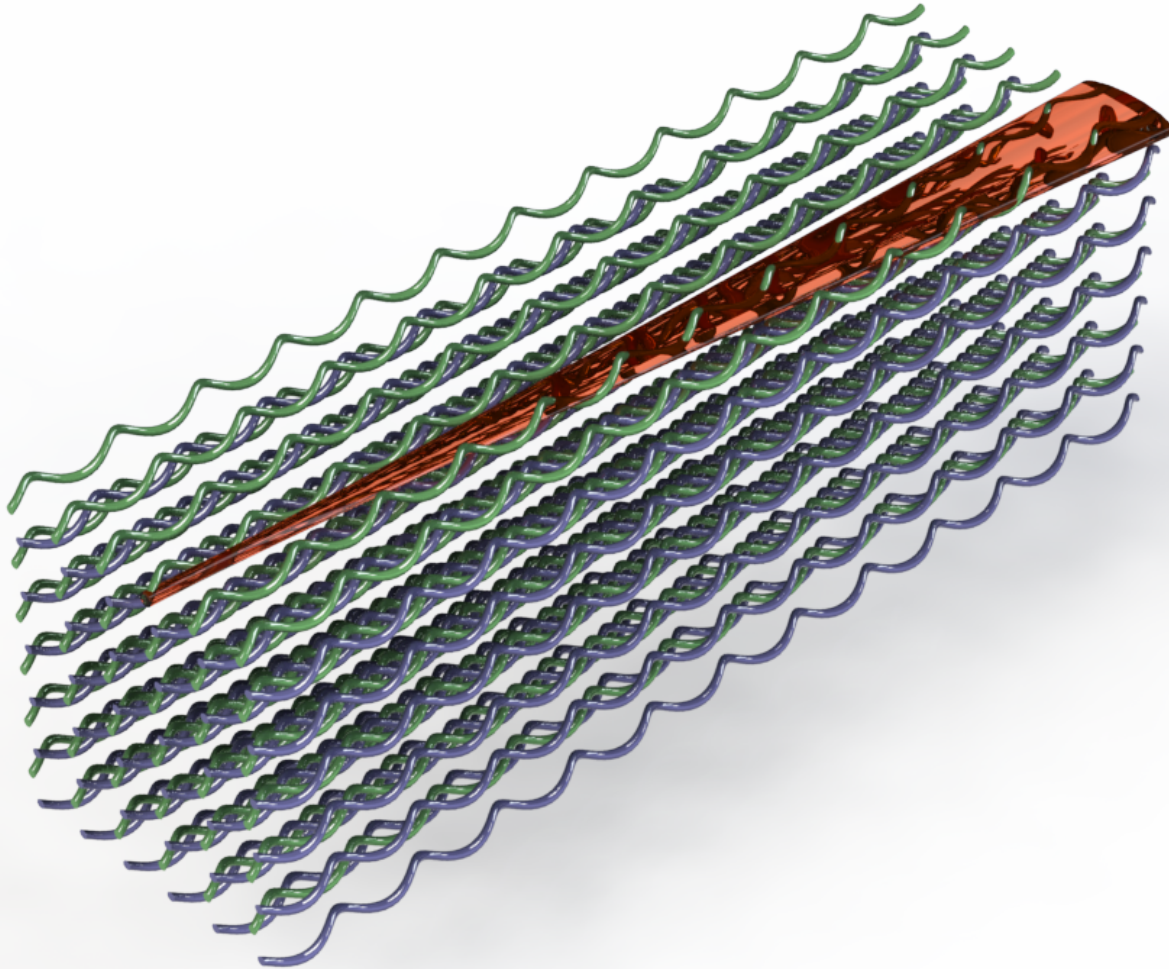

Experimental observation of Fermi arc surface states

$$a = 29 \mu\text{m}$$

Experiment

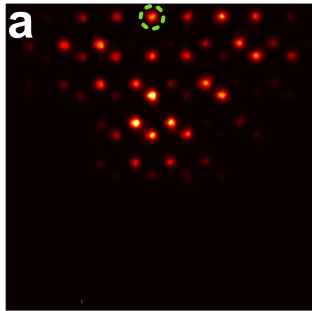

Simulation

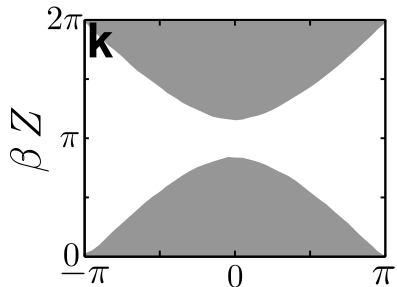
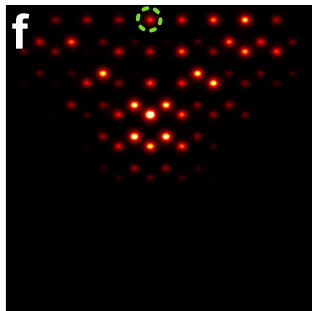

Thanks



Part 3: Topologically protected zero-modes in 2d systems

(collaboration with Taylor Hughes' group, UIUC and Chen group, Pittsburgh)

How else can we use topology to protect states?

Motivation: protecting modes in two-dimensional photonics

Photonic crystal slabs

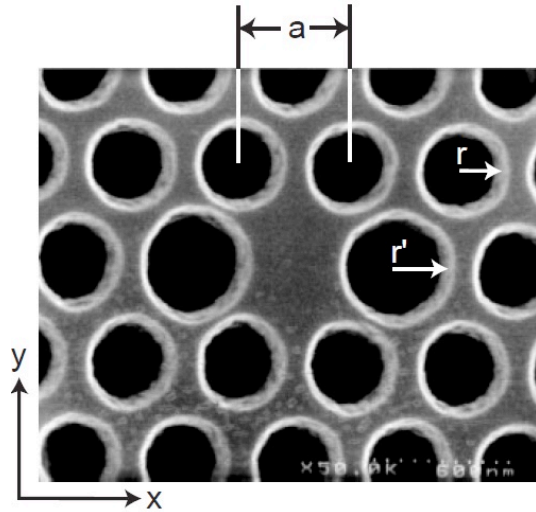

O. Painter *et al. Science* **284**, 1819 (1999)

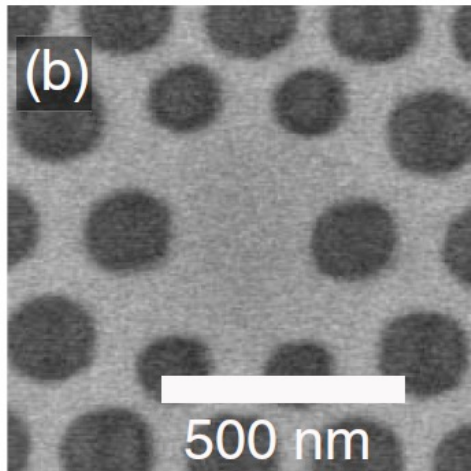

D. Englund *et al. Phys. Rev. Lett.* **95** (2005)

Photonic crystal fibers

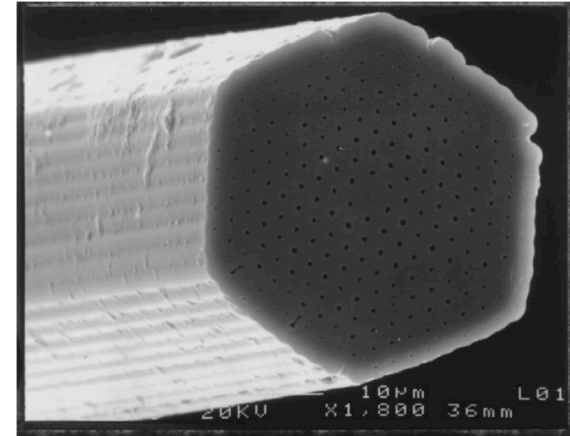

J.C. Knight *et al. Science* **284**, 1819 (1999)

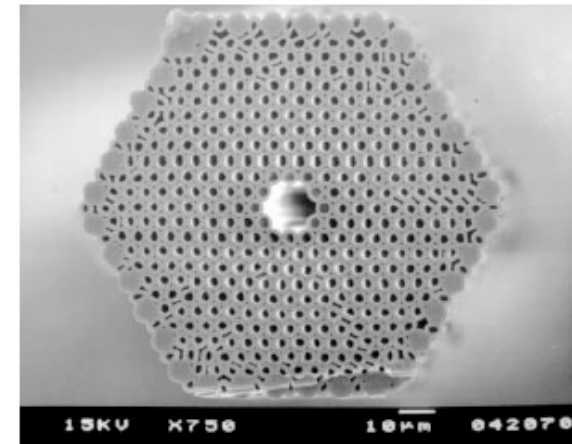

R.F. Cregan *et al. Science* **285**, 1537 (1999)

FAQ: what's the simplest TI model? Polyacetylene!

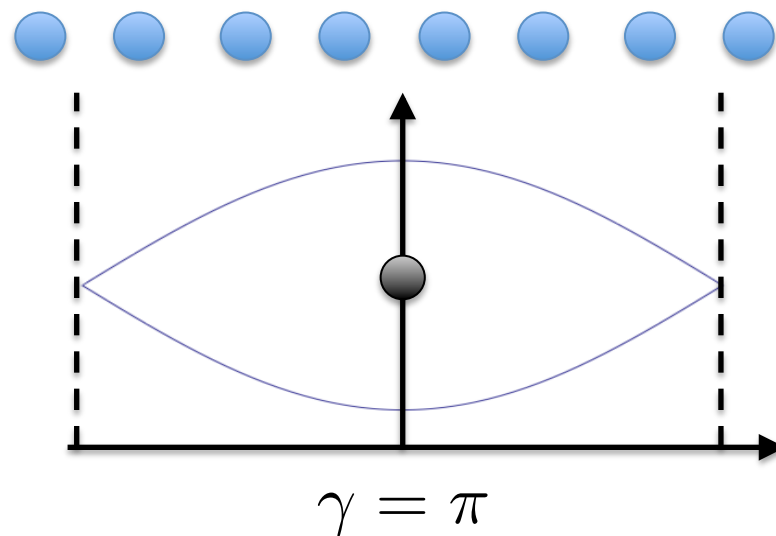
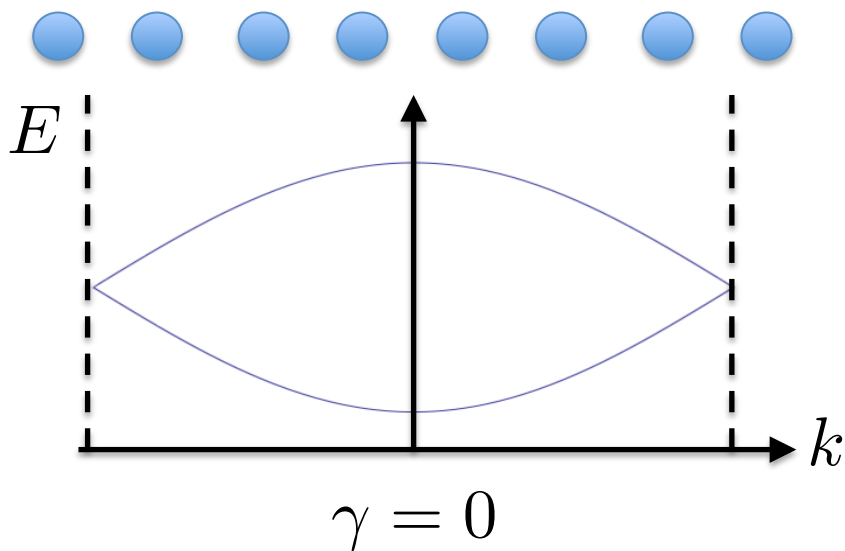
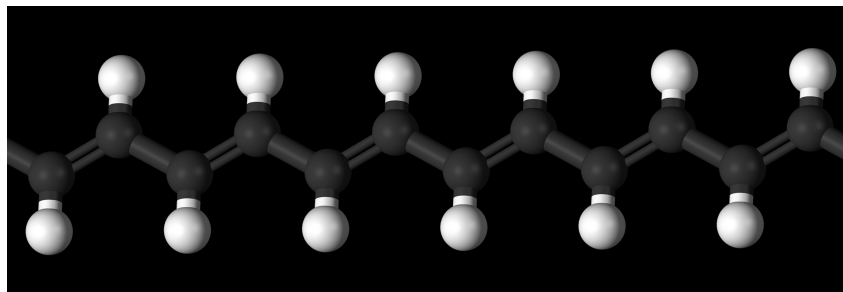

Zak phase / Winding number:

$$\gamma = i \int \langle \psi_k | \nabla_k | \psi_k \rangle \cdot d\mathbf{k}$$

Shockley / SSH states in 1d

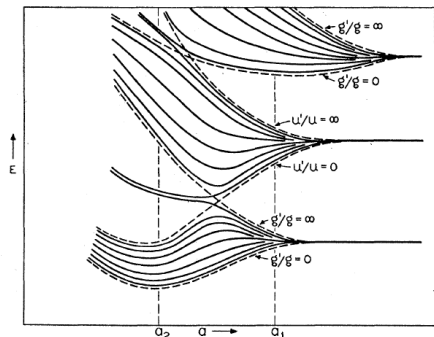
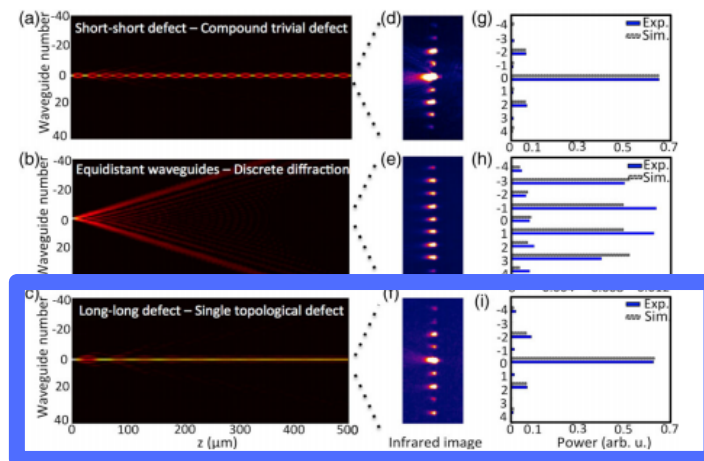
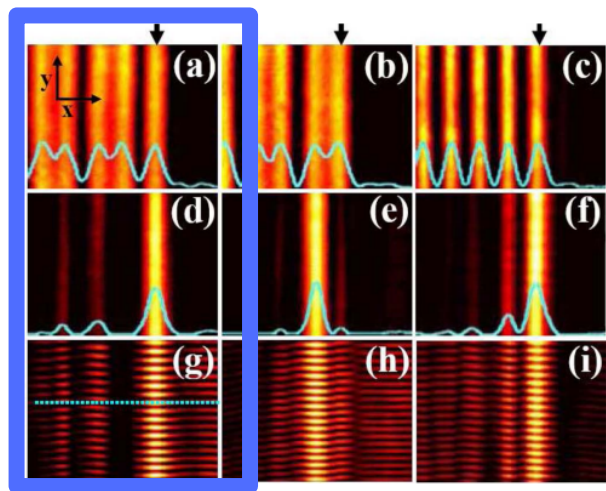

FIG. 2. Energy spectrum for a one-dimensional lattice with eight atoms.

W. Shockley *Phys. Rev.* **56**, 317 (1939)



A. Blanco-Redondo *et al.*,
Phys. Rev. Lett. **116**, 163901 (2016)



N. Malkova *et al.*, *Opt. Lett.* **34**, 1633 (2009)

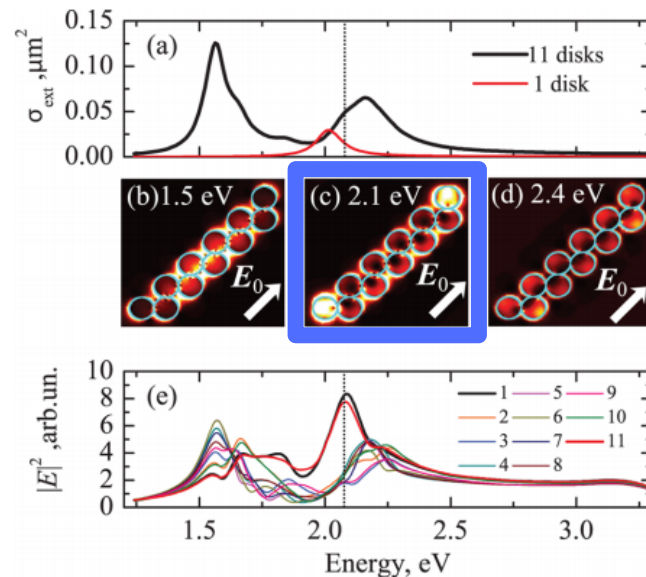

A. Poddubny *et al.*, *ACS Photonics* **5**, 101 (2014)

Shockley / SSH states in 1d

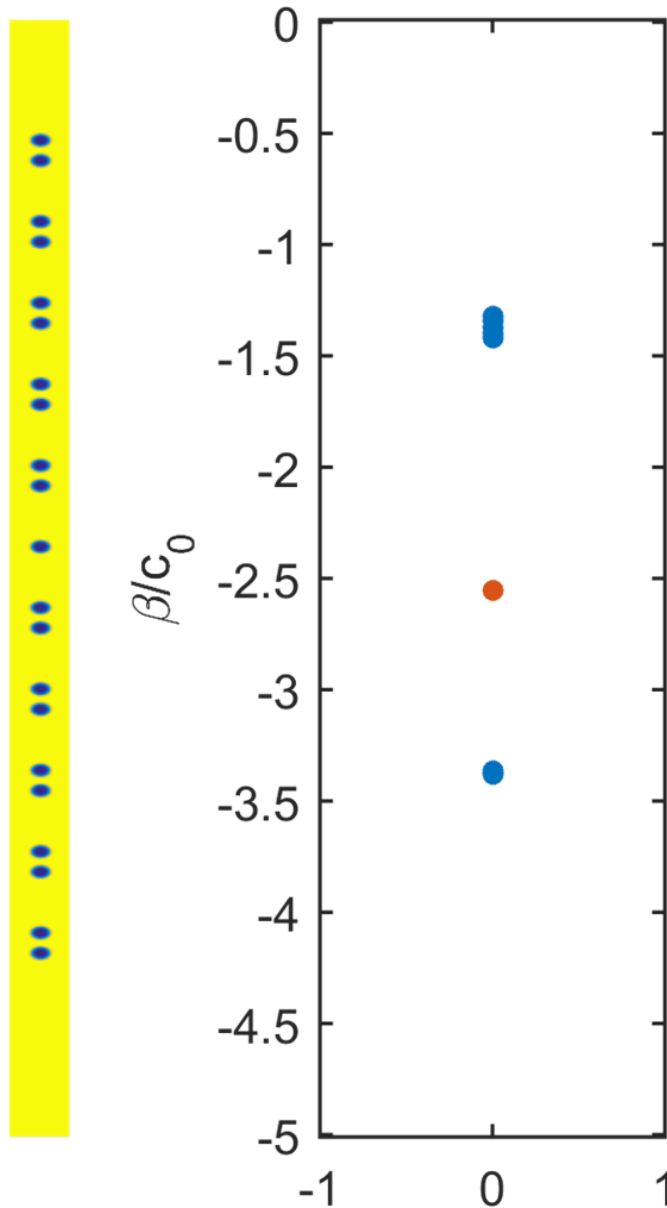

Protection against
off-site disorder!

SSH in 2d?

- Finding realizations of topological states that manifest themselves via defect states, e.g., corner or disclination localized modes
- Zero-dimensional defect modes in time-reversal invariant topological insulator structures:

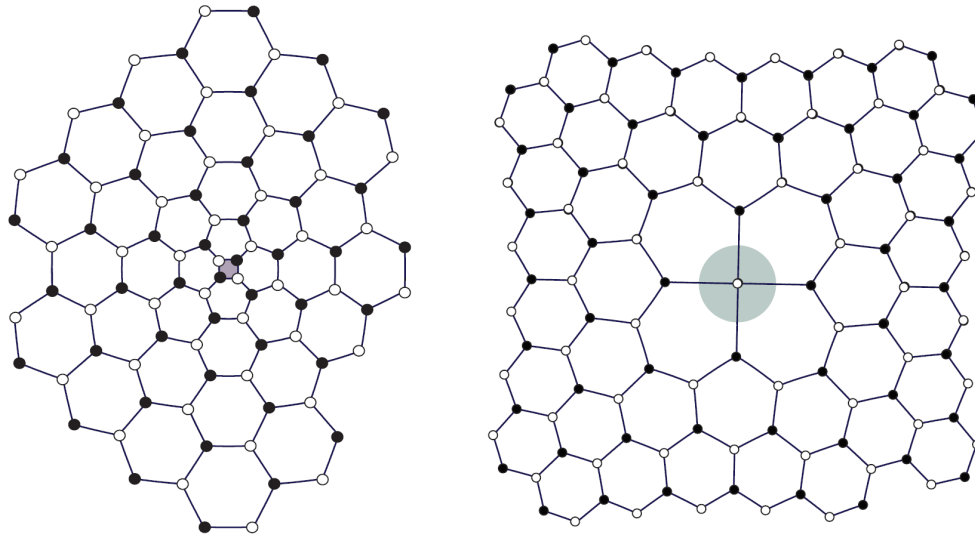

W. A. Benalcazar *et al.*, *Phys. Rev. B* **89** 224503 (2014) (T. Hughes Group)

Paraxial propagation and our structure

$$L/s = 3.53$$

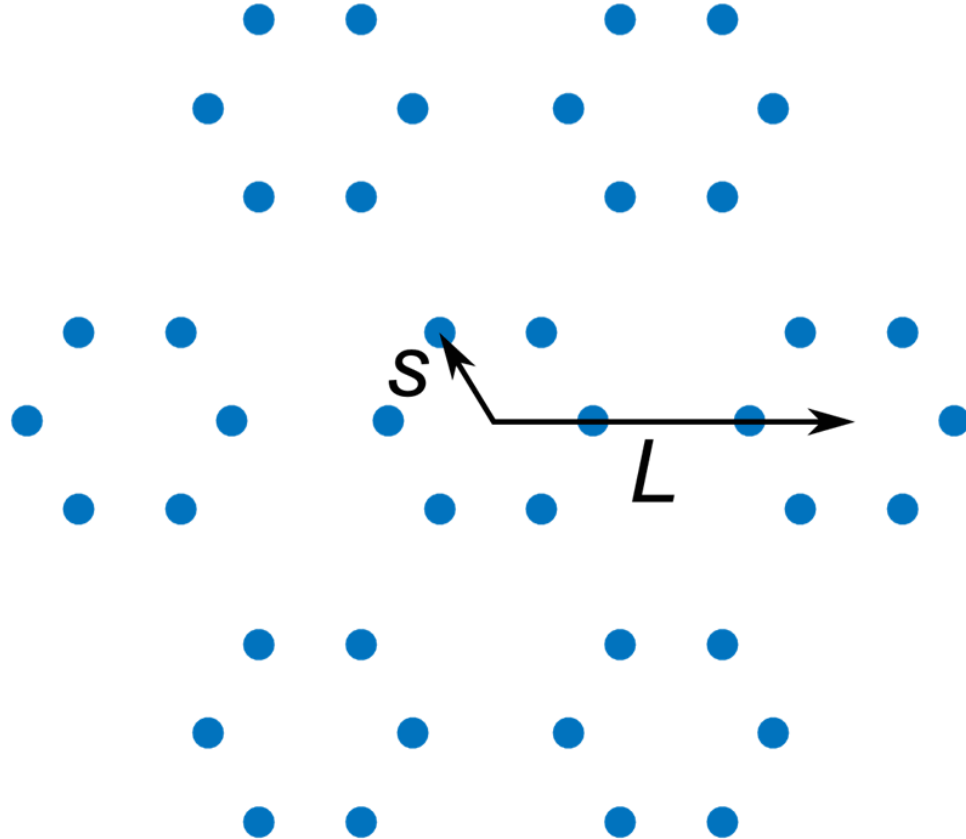

W. A. Benalcazar *et al.*, *Phys. Rev. B* **89** 224503 (2014)

L.-H. Wu *et al.*, *Phys. Rev. Lett.* **114**, 223901 (2015)

Barik *et al.*, *arXiv. 1605.08822* (2016)

Paraxial propagation and our structure

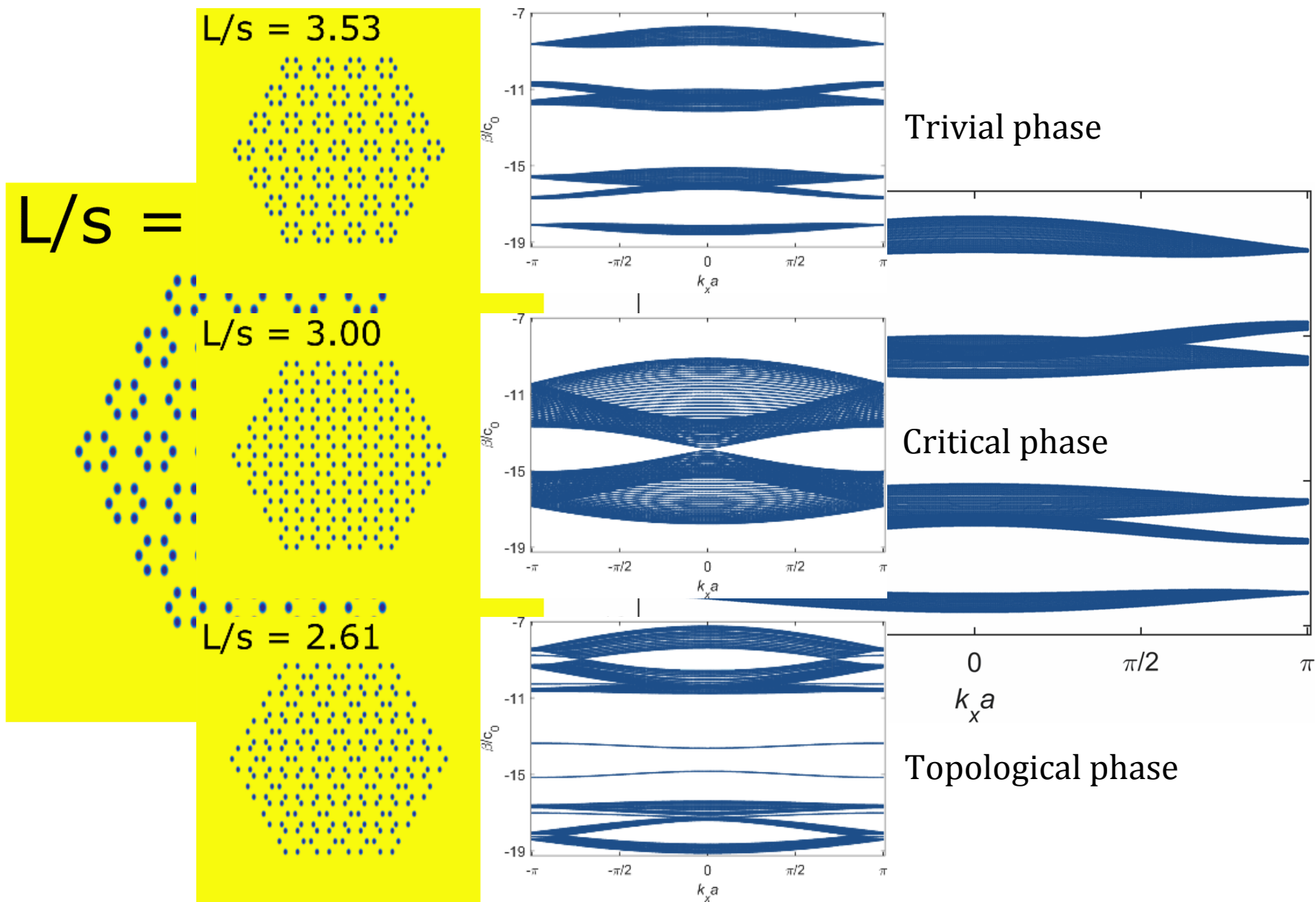

Protection of defect modes

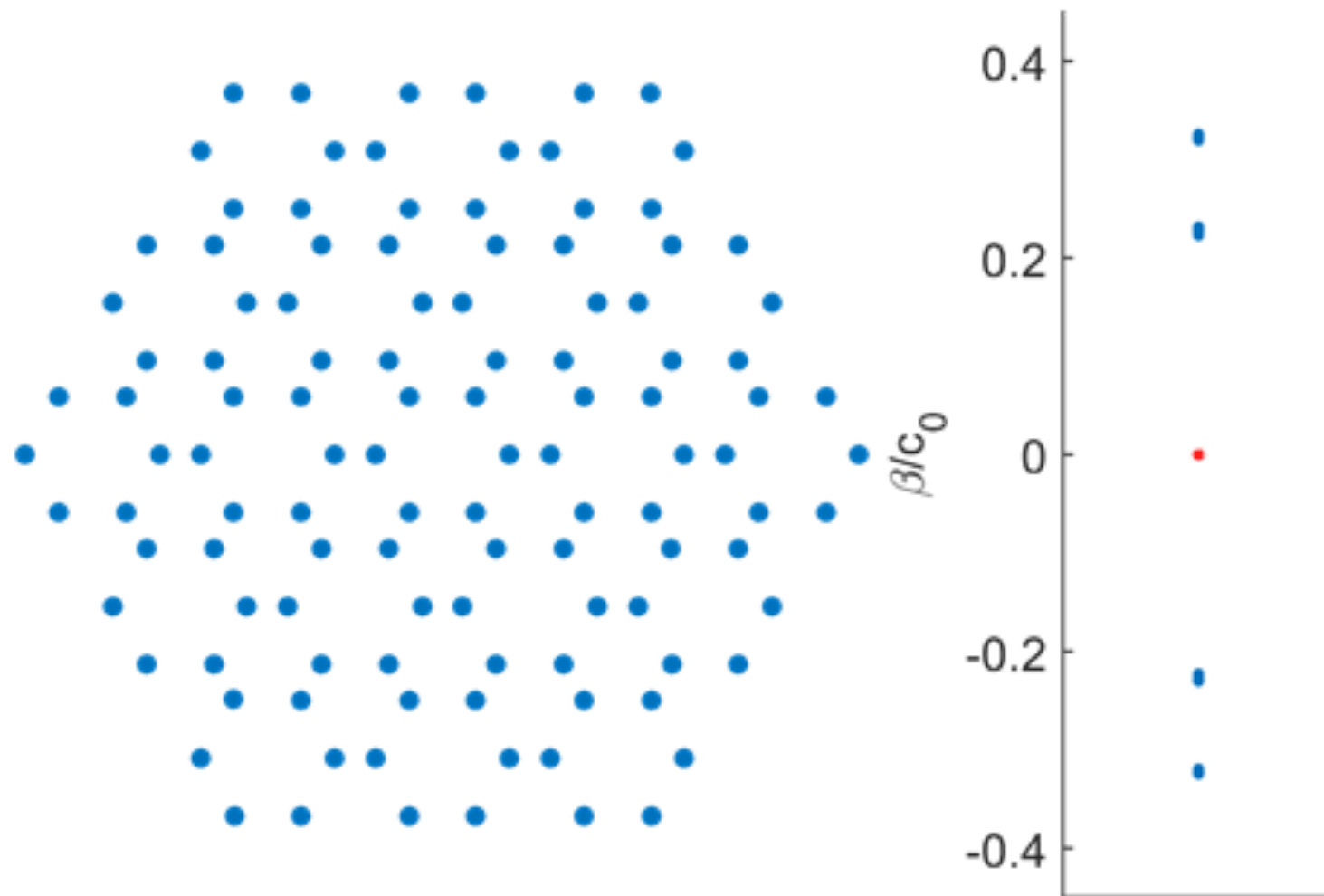

Paraxial propagation and our structure

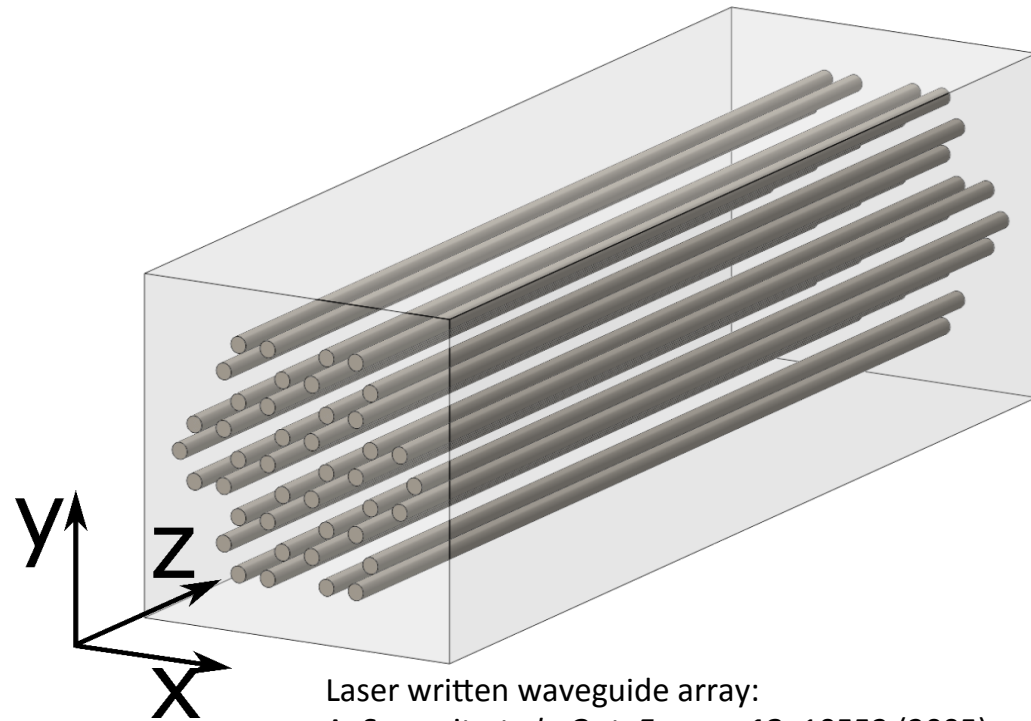

Laser written waveguide array:
A. Szameit *et al.*, *Opt. Express* **13**, 10552 (2005)

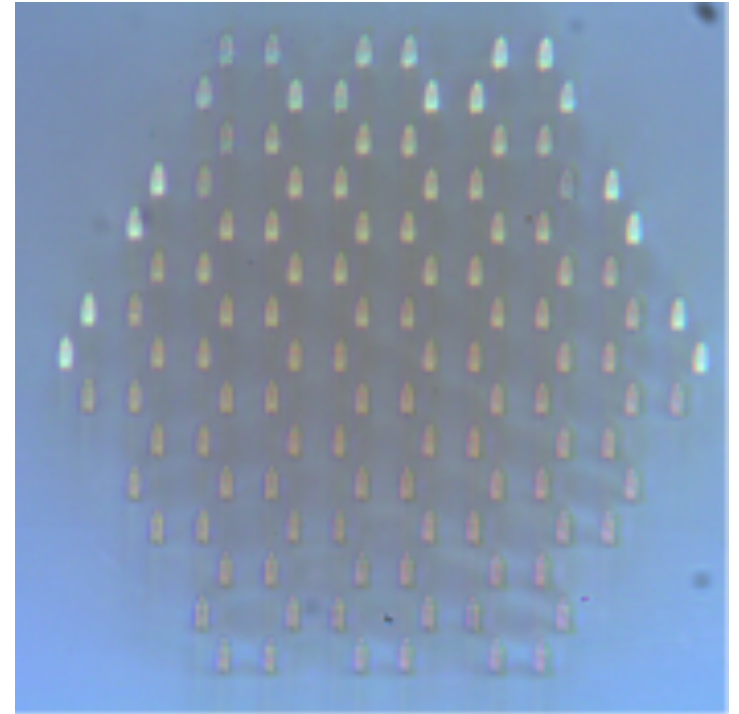

$$i\partial_z\psi(\mathbf{r}, z) = -\frac{1}{2k_0}\nabla_{\mathbf{r}}^2\psi(\mathbf{r}, z) - \frac{k_0\Delta n(\mathbf{r})}{n_0}\psi(\mathbf{r}, z)$$

$$i\partial_z\psi_i(z) = \sum_z c_{ij}(\lambda)\psi_j(z)$$

Experimental results

Increase in wavelength \rightarrow Evolution in time.



$\lambda=1450\text{nm}$

$\lambda=1550\text{nm}$

$\lambda=1650\text{nm}$

Trivial
 $L/s=3.53$

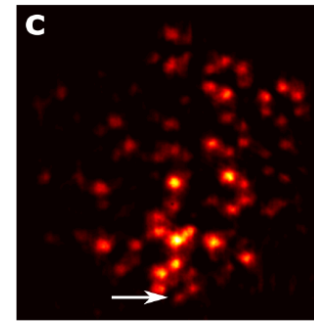
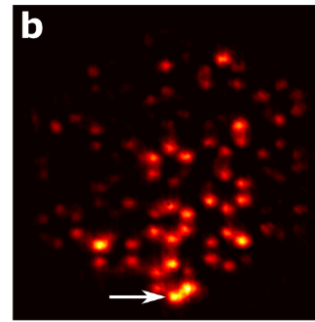
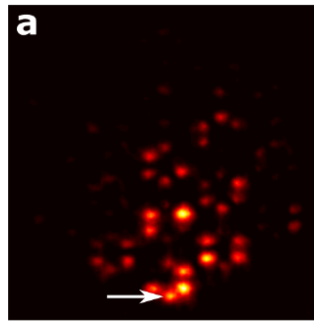

Critical
 $L/s=3.0$

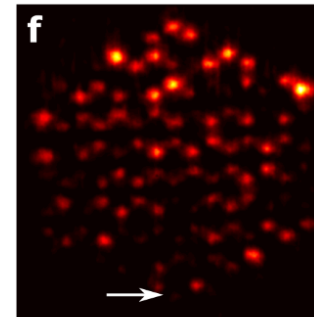
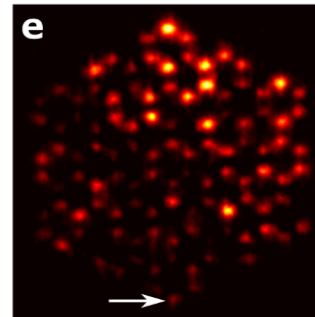
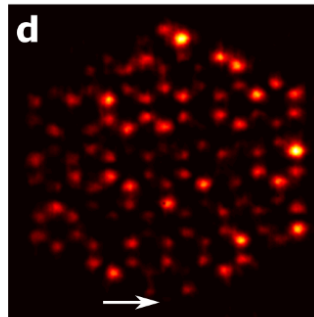

Non-trivial
 $L/s=2.61$

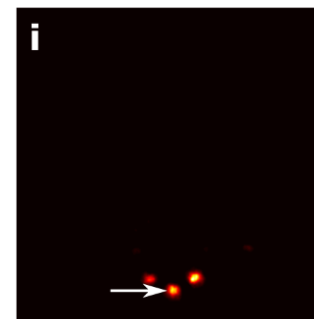
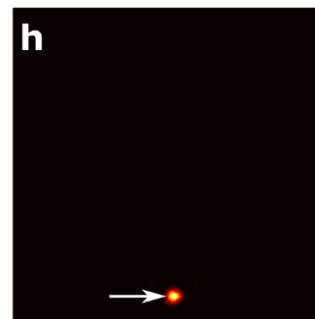
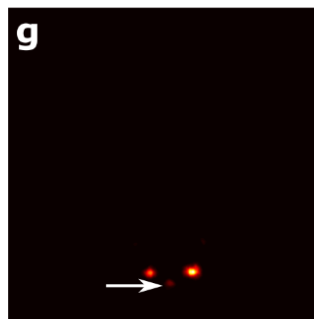

Our experimental observables

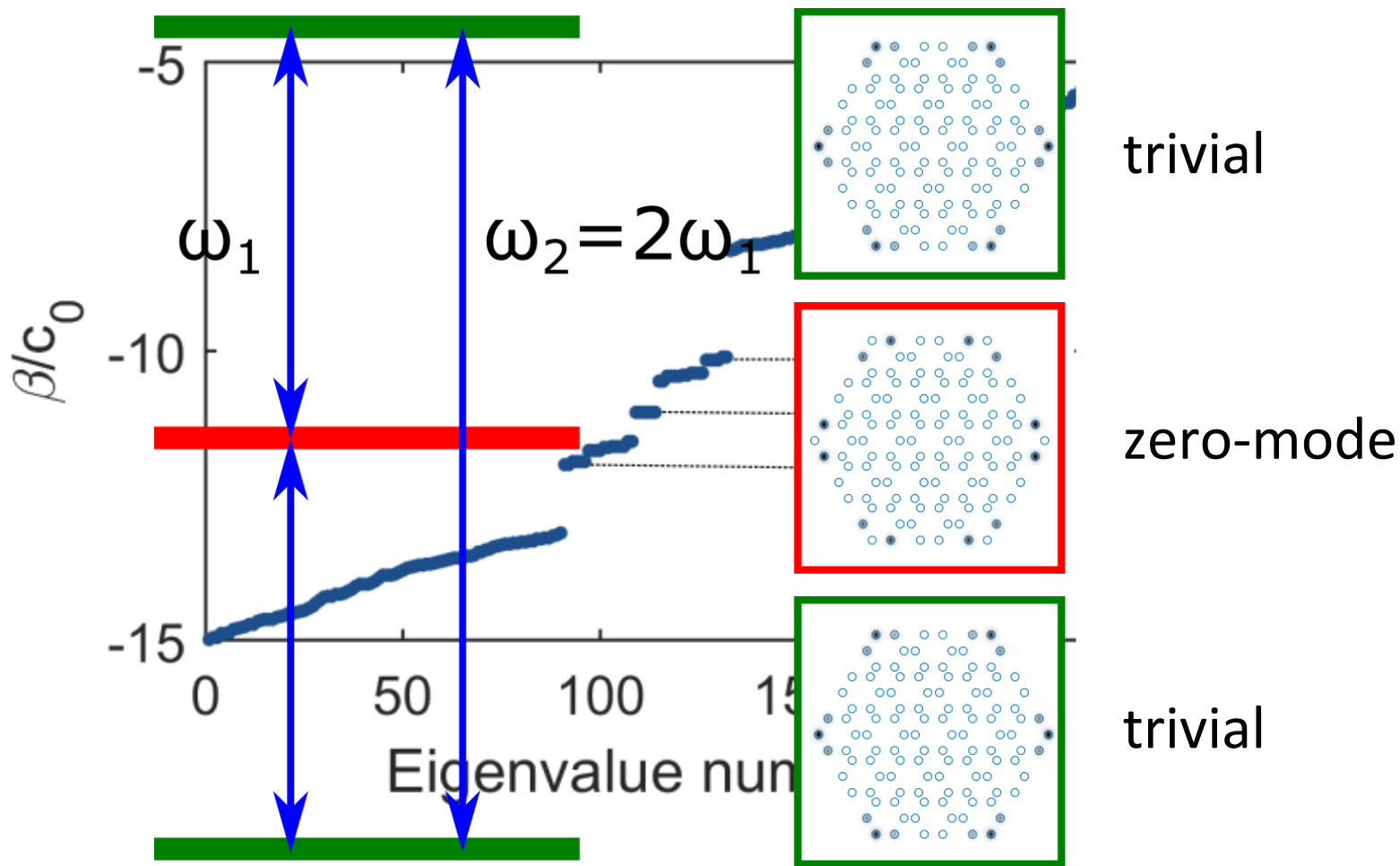

Experimental results

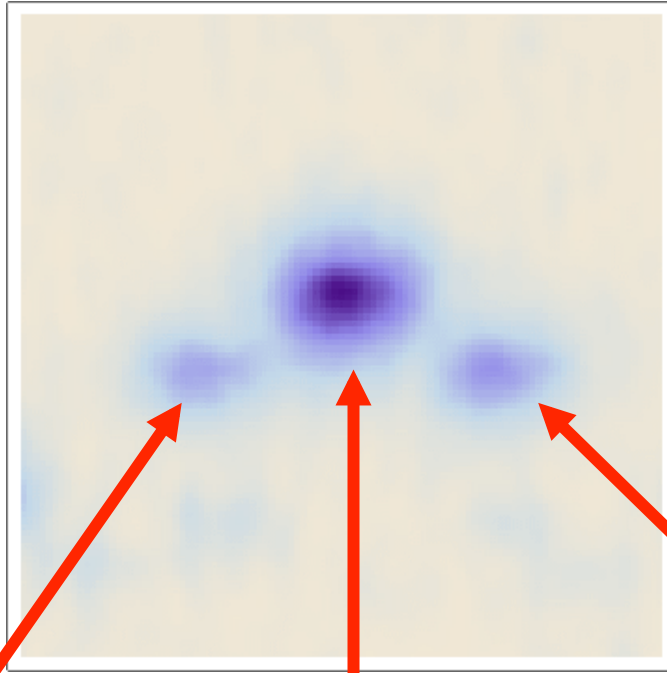
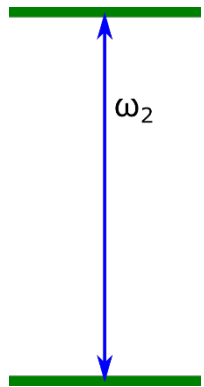

Frequency ratio:
Measured: 0.98 ± 0.09
Theory: 1.00

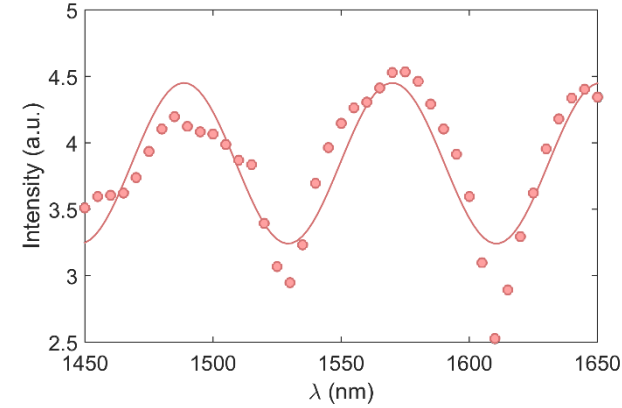
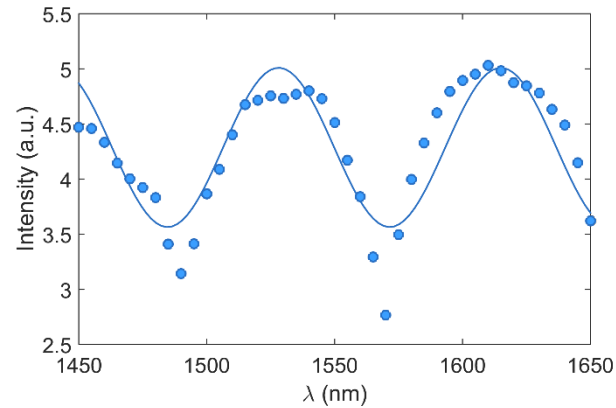
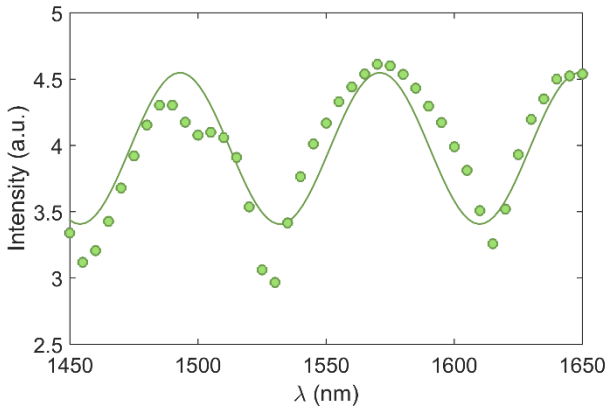
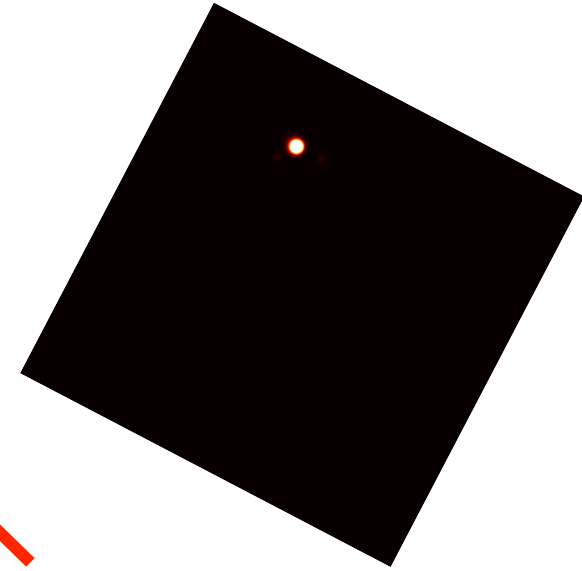

Experimental results

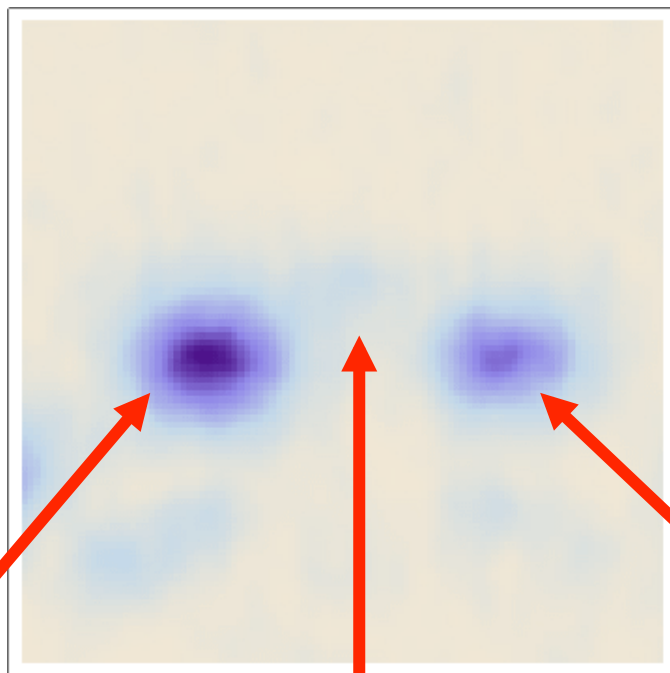
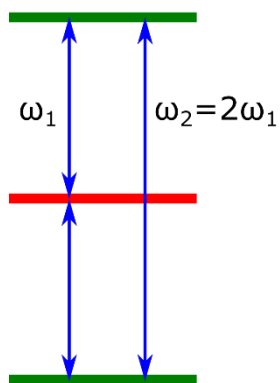

Frequency ratio:
Experiment: 1.99 ± 0.27
Theory: 2.00

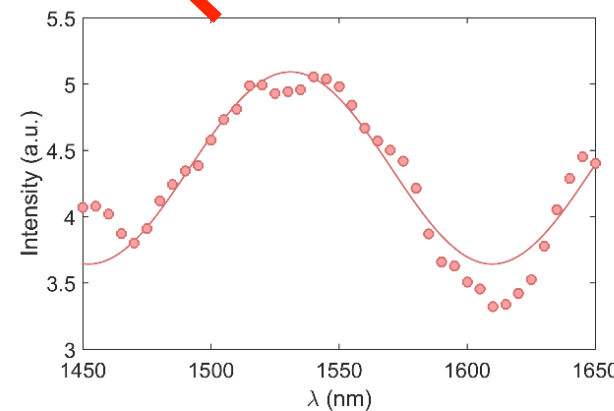
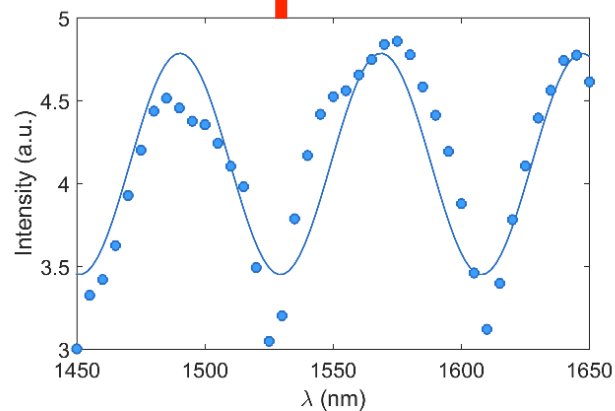
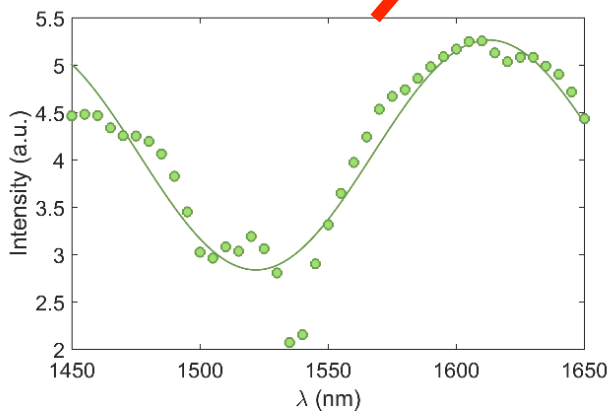
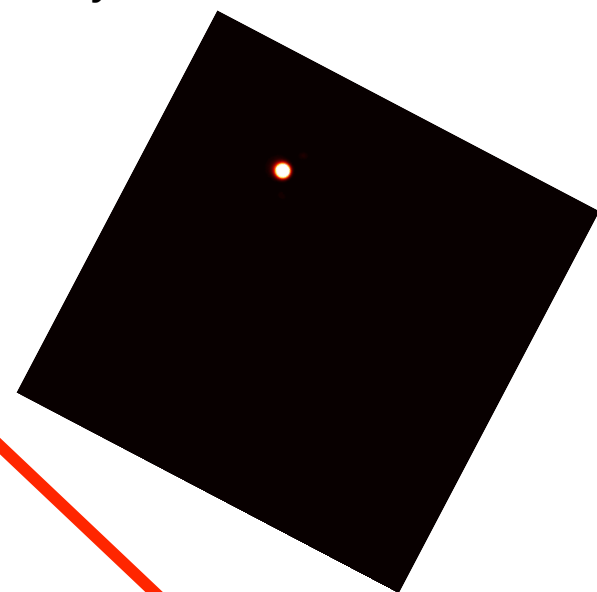

Thanks

